

**Standard
for
Fire
Safety
in
Rapid Transit Systems
2012 Edition**

CONTENTS

| | |
|---|----|
| Part I – Introduction | 1 |
| SECTION 1.1 - General | 1 |
| 1.1.1 Scope | 1 |
| 1.1.2 Purpose | 1 |
| 1.1.3 Characteristics of Fire Safety | 1 |
| 1.1.4 Abbreviations | 2 |
| Part II - Rapid Transit Station and Trainway | 3 |
| SECTION 2.1 – General | 3 |
| 2.1.1 Scope | 3 |
| 2.1.2 Definitions | 3 |
| 2.1.3 Station Occupancy | 14 |
| 2.1.4 Cable installation | 14 |
| SECTION 2.2 – Station Means of Escape | 17 |
| Performance-based Provisions | 17 |
| Root Objective | 17 |
| Sub-Objectives | 17 |
| Deem-to-satisfy Provisions | 18 |
| 2.2.1 General | 18 |
| 2.2.2 Occupant Load | 18 |
| 2.2.3 Means of Escape from Platform Public Area to Point of Safety | 20 |
| 2.2.4 Means of Escape from Commercial Spaces and Ancillary Areas | 22 |
| 2.2.5 Means of escape Requirements - General | 25 |
| SECTION 2.3 – Station Structural Fire Precautions | 48 |
| Performance-based Provisions | 48 |
| Root Objectives | 48 |
| Sub-Objectives | 48 |
| Deem-to-satisfy Provisions | 50 |
| 2.3.1 General | 50 |
| 2.3.2 Provision of Compartment Walls and Compartment Floors | 50 |
| 2.3.3 Fire Resistance of Elements of Structure | 54 |
| 2.3.4 Test of Fire Resistance | 57 |
| 2.3.5 External Wall | 58 |
| 2.3.6 Separating Walls | 59 |
| 2.3.7 Compartment Walls and Compartment Floors | 60 |
| 2.3.8 Protected Shafts | 61 |
| 2.3.9 Protection of Openings | 66 |
| 2.3.10 Exit Staircases | 69 |
| 2.3.11 Concealed Spaces | 70 |
| 2.3.12 Fire Stopping | 73 |

| | | |
|--------------------|---|------------|
| 2.3.13 | Restriction of Spread of flame Over Surfaces of Walls and Ceilings | 74 |
| 2.3.14 | Roofs | 74 |
| 2.3.15 | Materials for Construction | 75 |
| SECTION 2.4 | – Site Planning & External Fire Fighting | 83 |
| | Provisions for Stations | |
| | Performance-based Provisions | 83 |
| | Root Objectives | 83 |
| | Sub-Objectives | 83 |
| | Deem-to-satisfy Provisions | 84 |
| 2.4.1 | General | 84 |
| 2.4.2 | Provision of External Access to Station for Fire Fighting and Accessibility of Site to Fire Fighting Appliances | 84 |
| 2.4.3 | Access to Stations with Breeching Inlets | 87 |
| 2.4.4 | Private Fire Hydrant | 88 |
| SECTION 2.5 | – Fire Fighting Systems in Stations | 95 |
| | Performance-based Provisions | 95 |
| | Root Objectives | 95 |
| | Sub-Objectives | 95 |
| | Deem-to-satisfy Provisions | 97 |
| 2.5.1 | General | 97 |
| 2.5.2 | Portable Fire Extinguishers | 97 |
| 2.5.3 | Dry rising Main | 98 |
| 2.5.4 | Hose Reels | 101 |
| 2.5.5 | Electrical Fire Alarm System | 101 |
| 2.5.6 | Sprinkler Installation | 104 |
| 2.5.7 | Lifts | 106 |
| SECTION 2.6 | – Station Smoke Control and Mechanical Ventilation Systems | 108 |
| | Performance-based Provisions | 108 |
| | Root Objectives | 108 |
| | Sub-Objectives | 108 |
| | Deem-to-satisfy Provisions | 110 |
| 2.6.1 | General | 110 |
| 2.6.2 | Air-conditioning & Mechanical Ventilation Systems | 110 |
| 2.6.3 | Engineered Smoke Control System | 113 |
| 2.6.4 | Smoke Purging System | 113 |
| 2.6.5 | Underground Station Trainway and Enclosed Station Emergency Ventilation System | 115 |
| SECTION 2.7 | – Other Systems in Stations | 119 |
| | Performance-based Provisions | 119 |
| | Root Objectives | 119 |
| | Sub-Objectives | 119 |
| | Deem-to-satisfy Provisions | 121 |
| 2.7.1 | Exit Lighting and Exit Sign | 121 |
| 2.7.2 | Voice Communication system | 124 |

| | | |
|---------------------|--|------------|
| 2.7.3 | Hotline Telephone Between Stations and OCC | 126 |
| 2.7.4 | Signage for Firemen | 126 |
| 2.7.5 | Plans for Firemen | 126 |
| 2.7.6 | Fire Command Centre | 127 |
| SECTION 2.8 | – Integration and Interface for Stations | 129 |
| | Performance-based Provisions | 129 |
| | Root Objectives | 129 |
| | Sub-Objectives | 129 |
| | Deem-to-satisfy Provisions | 130 |
| 2.8.1 | General | 130 |
| 2.8.2 | Stations with Multiple Transit Lines | 130 |
| 2.8.3 | Stations with Interchange-Link | 130 |
| 2.8.4 | Stations Connected to Non-transit Occupancies | 131 |
| SECTION 2.9 | – Underground or Enclosed Trainway | 134 |
| | Performance-based Provisions | 134 |
| | Root Objectives | 134 |
| | Sub-Objectives | 134 |
| | Deem-to-satisfy Provisions | 137 |
| 2.9.1 | Construction Materials | 137 |
| 2.9.2 | Exits | 137 |
| 2.9.3 | Exit Signs and Emergency Lighting | 139 |
| 2.9.4 | Fire Protection | 140 |
| 2.9.5 | Communication | 141 |
| 2.9.6 | Emergency Ventilation System | 141 |
| 2.9.7 | Access to Underground or Enclosed Trainway Portal | 143 |
| 2.9.8 | Motorised Trolley | 144 |
| SECTION 2.10 | – Aboveground Trainway | 148 |
| | Performance-based Provisions | 148 |
| | Root Objectives | 148 |
| | Sub-Objectives | 148 |
| | Deem-to-satisfy Provisions | 149 |
| 2.10.1 | Construction Materials | 149 |
| 2.10.2 | Setback Distance | 149 |
| 2.10.3 | Emergency Access | 150 |
| 2.10.4 | Egress for Passengers | 150 |
| Part III | – RTS Depot and Related Facility Buildings | 152 |
| SECTION 3.1 | – Depot | 152 |
| | Performance-based Provisions | 152 |
| | Deem-to-satisfy Provisions | 153 |
| 3.1.1 | General | 153 |
| 3.1.2 | Two-way Emergency Voice Communication System | 155 |
| 3.1.3 | Radio Communication | 155 |
| 3.1.4 | Design Fire Size and Perimeter | 155 |

| | |
|---|-----|
| SECTION 3.2 – OCC and RTS Facility Buildings | 157 |
| Performance-based Provisions | 157 |
| Root Objectives | 157 |
| Sub-Objectives | 157 |
| Deem-to-satisfy Provisions | 159 |
| 3.2.1 Operation Control Centre | 159 |
| 3.2.2 RTS Facility Buildings | 159 |
| | |
| Part IV – Electrical System for Rapid Transit Systems | 160 |
| | |
| SECTION 4.1 – Electrical System for Rapid Transit Systems | 160 |
| Performance-based Provisions | 160 |
| Root Objectives | 160 |
| Deem-to-satisfy Provisions | 161 |
| 4.1.1 Scope | 161 |
| 4.1.2 Installation | 161 |
| 4.1.3 Primary and Secondary Power Supplies | 161 |
| | |
| Appendix A – Occupant Load Calculations | |
| | |
| Appendix B – Exiting Analysis | |
| | |
| Appendix C – Notional Periods of Fire Resistance | |
| | |
| Appendix D – Permitted Limits of Unprotected Areas | |
| | |
| Appendix E – Accessway | |
| | |
| Appendix F – Standby Fire Hose for Rising Main | |
| | |
| Appendix G – Tenable Environment | |
| | |
| Appendix H – Notes on the Use of Intumescent Paints for Protection to Structural Steel Members of Stations | |
| | |
| Appendix J – Fire Safety Requirements for Rapid Transit Stations for Persons With Disabilities | |

PART I - INTRODUCTION

SECTION 1.1 GENERAL

1.1.1 SCOPE

- 1.1.1.1 The Standard shall cover fire protection and life safety requirements for underground, surface, and elevated Rapid Transit Systems including trainways, transit stations, and train maintenance depot, on-line electric substation and Rapid Transit System facility buildings. Transit stations shall pertain to stations accommodating only passengers and employees of the Rapid Transit Systems and incidental occupancies in the stations.

This Standard shall not cover requirements for the following:

- (a) Conventional freight or passengers railroad systems including those that provide commuter services.
- (b) Buses and trolley coaches.
- (c) Any other system of transportation not included in the definition of Rapid Transit Systems.

1.1.2 PURPOSE

- 1.1.2.1 The purpose of this Standard is to establish minimum requirements that will provide an acceptable degree of safety from fire and its related hazards.

1.1.3 CHARACTERISTICS OF FIRE SAFETY

- 1.1.3.1 Fire safety on a Rapid Transit System shall be achieved through a composite of facility design, operating equipment and hardware, procedures, and software subsystems that are integrated to provide requirements for the protection of life and property from the effects of fire. The level of fire safety desired for the whole system shall be achieved by integrating the required levels for each subsystem.

Scope

Purpose

Characteristics
of fire safety

The abbreviations used in this Standard:-

| | |
|------|---------------------------------------|
| ANSI | American National Standards Institute |
| BS | British Standard |
| CD | Civil Defence |
| Cl. | Clause |
| CP | Code of Practice |
| FCC | Fire Command Centre |
| OCC | Operation Control Centre |
| PSB | PSB Corporation |
| PSC | Passenger Service Centre |
| PUB | Public Utilities Board |
| RTS | Rapid Transit System |
| SCDF | Singapore Civil Defence Force |
| SS | Singapore Standard |
| PWDs | Persons With Disabilities |

PART II - RAPID TRANSIT STATION AND TRAINWAY

SECTION 2.1 GENERAL

2.1.1 SCOPE

Part II of this Standard shall cover the fire protection and life safety requirements for underground, surface, and elevated Rapid Transit Systems including transit stations and trainways. Transit stations shall pertain to stations accommodating only passengers and employees of the Rapid Transit Systems and incidental occupancies in the stations.

Scope

2.1.2 DEFINITIONS

2.1.2.1 Aboveground station means a station with its trainway located at or above ground level.

Aboveground station

2.1.2.2 Aboveground trainway means that portion of the guideway which are supported by elevated structure or ground level structure or embankment or cut slope.

Aboveground trainway

2.1.2.3 Ancillary area means the non-public areas used to house or contain operating, maintenance, or support equipment and functions. It shall also include staff rooms, locker rooms, and general purpose offices.

Ancillary area

2.1.2.4 Area of Station

Area of station

(a) The area of any storey of a station or compartment shall be taken to be the total area of that storey bounded by the inner finished surfaces of the enclosing walls or, on any side where there is no enclosing walls, by the outermost edge of the floor on that side.

(b) The area of any room or space shall be taken to be the total area of its floor bounded by the inner finished surfaces of the walls forming the room or space.

(c) The area of any part of a roof shall be taken to be the actual visible area of such part measured on a plane parallel to the pitch of the roof.

| | | |
|---------|--|-----------------|
| 2.1.2.5 | Area of Refuge | Area of refuge |
| | <p>(a) In the station under consideration, an area of refuge is an area adequately separated from the rest of the station by fire resisting construction (see Section 2.3 for details), and evacuees from the rest of the station enter the area of refuge using an external corridor that links this area to the rest of the station. An area of refuge may serve as required exit in lieu of the provisions given under Cl.2.1.2.27.</p> <p>(b) An area of refuge may also be an area in an adjoining station which is separated from the station under consideration by fire resisting construction and evacuees similarly enter this area of refuge using an external corridor.</p> <p>(c) An area of refuge shall always be accessible.</p> | |
| 2.1.2.6 | An atrium within a station is a large open space created by an opening, or a series of openings, in floor assemblies, thus connecting two or more storeys. Atrium is covered at the top and is used for purposes other than those associated with small shafts, such as for stairs, elevators and various services. The sides of the atrium may be open to all floors, to some of the floors or closed to all or some floors by non-rated or rated fire-resistance construction. | Atrium |
| 2.1.2.7 | Backlayering means the reversal of movement of smoke and hot gases counter to the direction of the ventilation airflow. | Backlayering |
| 2.1.2.8 | Basement Storey | Basement storey |
| | <p>(a) A storey of a station which is below the first storey and the floor of which is situated at such a level that more than half the height of such storey is below the level of the ground adjoining its perimeter walls for more than half the length of such perimeter walls, and</p> <p>(b) Where the station has no storey above ground, a storey the floor of which is situated at such a level that either the whole storey is below ground or more than half the height of such storey is below the level of the ground adjoining its perimeter walls for more than half the length of such perimeter walls.</p> | |

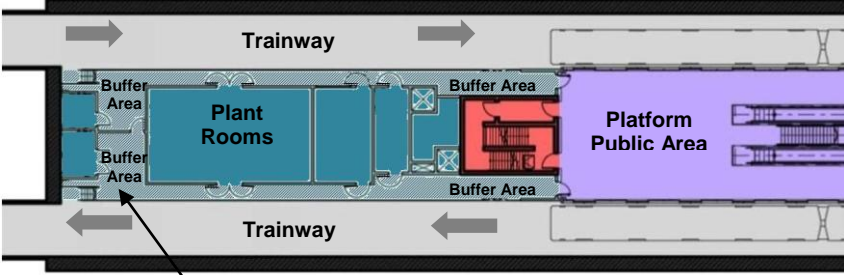
| | | |
|---|---|--|
| 2.1.2.9 | The boundary of the land belonging to the station under consideration, and including the imaginary extension of the boundary up to the centre of an abutting public street, canal or river. | Boundary |
| 2.1.2.10 | Buffer areas are unenclosed corridors located alongside trainways and are inaccessible to the public. | Buffer areas |
|  <p data-bbox="533 831 1038 891">Buffer area linking different bounds of trainways shall be as direct as practicable.</p> | | |
| 2.1.2.11 | <p data-bbox="360 943 667 972">Construction provided :</p> <p data-bbox="360 1016 1155 1084">(a) To seal a cavity (concealed space) against the penetration of smoke and flame, or</p> <p data-bbox="360 1128 1155 1196">(b) Within a cavity (concealed space) to stop the movement of smoke and flame within the cavity.</p> | Cavity barrier |
| 2.1.2.12 | A part of a station or trainway that encloses and is exposed overhead in a room, circulation space or protected shaft. (A soffit or rooflight is included as part of its surface, but not the frame of a rooflight.) | Ceiling |
| 2.1.2.13 | A space mainly used as means of access between a room or protected shaft and an exit from the station or compartment. It shall not be used for putting up any commercial activity such as information and reception counter, exhibition and the like. | Circulation space |
| 2.1.2.14 | A part of a station or trainway separated from all other parts of the same station or trainway by compartment walls and/or compartment floors. A roof space above the top storey of a compartment is included in that compartment. | Compartment |
| 2.1.2.15 | A wall or a floor which is provided for the purpose of dividing a station into compartments for the purposes of Cl.2.3.2 and complies with Cl.2.3.7. | Compartment wall and compartment floor |

| | | |
|----------|---|--|
| 2.1.2.16 | A space enclosed by elements of a station (including a suspended ceiling or raised floor) or contained within an element but not a room, cupboard, circulation space, protected shaft or space within a flue, chute, duct, pipe or conduit. | Concealed space (cavity) |
| 2.1.2.17 | A passage providing means of access from rooms or spaces to an exit. | Corridor |
| 2.1.2.18 | Critical velocity means the minimum steady-state velocity of the ventilation airflow moving toward the fire within a tunnel or passageway that is required to prevent backlayering at the fire site. | Critical velocity |
| 2.1.2.19 | <p>The cubical extent of a station or compartment shall be ascertained by measuring the volume of space contained within the station or compartment :</p> <p>(a) The inner finished surfaces of the enclosing walls or, on any side where there is no enclosing walls, a plane extending vertically above the outermost edge of the floor on that side,</p> <p>(b) The upper surface of its lowest floor, and</p> <p>(c) In the case of a station or compartment which extends to a roof, the under surface of the roof or, in the case of any other compartment, the under surface of the ceiling of the highest storey within the compartment, including the space occupied by any other wall, or any unprotected shafts, ducts or structure within the space to be so measured, but excluding protected lift walls, exit staircases and other accommodation (such as lavatory and locker rooms) which are enclosed with walls having fire resistance of not less than one hour and openings protected by doors of one half hour fire resistance fitted with automatic self-closing device.</p> | Cubical extent of station or compartment |
| 2.1.2.20 | A dead-end is a situation within a space, normally a corridor or lift lobby spaces, where exit is only possible from one end, with no possible escape from the other end. | Dead-end |
| 2.1.2.21 | Detraining load means the number of passengers alighting from a train at a platform. | Detraining load |

| | | |
|-----------------|--|--------------------------------------|
| 2.1.2.21 (A) | The shortest distance from the most remote point in a room or space, measured within the external enclosures of the room or space to the relevant exits, ignoring internal walls, partitions and fittings other than the enclosure walls of exit passageways and exit staircases. | Direct distance |
| 2.1.2.22 | Includes any shutter, cover or other form of protection to an opening in any wall or floor or in the structure surrounding a protected shaft, regardless of whether the door is constructed of one or more leaves. | Door |
| 2.1.2.23 | <p>Element of Structure</p> <p>(a) A member forming part of the structural frame of a station or trainway or any other beam or column but not a member forming part of a roof structure only,</p> <p>(b) A load bearing wall or load bearing part of a wall,</p> <p>(c) A floor, including a compartment floor, other than the lowest floor (in contact with the ground),</p> <p>(d) An external wall,</p> <p>(e) A separating wall,</p> <p>(f) A compartment wall, and</p> <p>(g) A structure enclosing a protected shaft (protecting structure).</p> | Element of structure |
| 2.1.2.24 | <p>Emergency Lighting and Exit Lighting</p> <p>(a) Emergency lighting means lighting provided with a secondary source of power supply.</p> <p>(b) Exit lighting means that part of emergency lighting that is provided to illuminate the exits.</p> | Emergency lighting and exit lighting |
| 2.1.2.25 | Engineering analysis is an analysis that evaluates all factors that affect the fire safety of the system. A report of the analysis indicating the proposed method(s) that will provide a level of fire safety commensurate with this Standard shall be submitted. | Engineering analysis |
| 2.1.2.26 | Entraining load means the number of passengers boarding a train during a given period. | Entraining load |

| | | |
|-----------------|--|--------------------------|
| 2.1.2.27 | A means of egress from the interior of the station or trainway to an exterior space which is provided by the use of the following either singly or in combination: exterior door openings, exit staircases, exit ramps or exit passageways but not including access stairs, aisles, corridor doors or corridors. In the case of ancillary area and commercial space in stations, exit also include door opening directly to station public area. | Exit |
| 2.1.2.28 | A door provided at the doorway of an exit for the passage of people, forming part of the integrity of the exit, including the exterior door opening. | Exit door |
| 2.1.2.29 | That portion of a means of escape that leads to an exit. It includes the room and building spaces that people occupy, the doors along the escape routes, lobbies, aisles, passageways, corridors, access stairs and ramps that will be traversed in order to reach an exit. | Exit access |
| 2.1.2.29 (A) | A door which provides access to a room or space (excluding toilet cubicle, bedroom, storeroom, utility room, pantry and the like) or installed across the escape path leading to an exit. Exit access door shall comply with all the requirements of an exit door and need not have fire resistance rating, unless it is specified. | Exit access door |
| 2.1.2.30 | A horizontal extension of a vertical exit viz exit staircase or a passage leading from a habitable area to the station public area or an open exterior space, complying with the requirements of Cl.2.3.8 for protected shafts in respect of fire resistance ratings for enclosure walls, floors, ceilings and doors, that serves as a required exit. | Exit passageway |
| 2.1.2.31 | A staircase that has its enclosure constructed of non-combustible material having a fire resistance of not less than the minimum period required by Cl.2.3.3 and Cl.2.9.1 for Elements of Structure for the part of the station and trainway in which it is situated. | Exit staircase |
| 2.1.2.32 | Material fixed to the outside face of an external wall for weather protection or decorative purpose. | External cladding |
| 2.1.2.33 | An exit staircase opens to the outdoor air that serves as a required exit. | External exit staircase |
| 2.1.2.34 | An exit passageway opens to the outdoor air that serves as a required exit. | External exit passageway |

| | | |
|----------|---|--------------------------------------|
| 2.1.2.35 | An outer wall or vertical enclosure, including a part of the roof pitched at an angle of 70 degrees or more to the horizontal if that part of the roof adjoins a space within the station to which persons have access. | External wall (or side of a station) |
| 2.1.2.36 | The minimum period of time during which an element of structure or element of a station/trainway may be expected to function satisfactorily while subjected to a standard fire test. | Fire resistance |
| 2.1.2.37 | A seal provided to close an imperfection of fit or any joint between elements, components or construction so as to prevent and restrict penetration of smoke and flame through that imperfection or joint. | Fire stop |
| 2.1.2.38 | A smoke-stop lobby which is adjacent to a fire lift or firemen's staircase and designated for use by the fire fighting team during an emergency. | Fire-fighting lobby |
| 2.1.2.39 | Firemen's staircase means a staircase that has its enclosure constructed of non-combustible material and shall have a fire resistance of not less than that for the element of structure and designated for use by firemen. | Firemen's staircase |
| 2.1.2.40 | Guideway means that portion of the transit line within right-of-way fences, outside lines of curbs or shoulders, underground tunnels, cut or fill slopes, ditches, channels, and waterways, and including all appertaining structures. | Guideway |
| 2.1.2.41 | A floor or part thereof, including roof level, regardless whether it is opened to sky or not, designated to be used for any purpose/activity other than housing lift motors, fire pumps, water supply pumps, cooling towers and water tanks. Such purpose/activity shall include terrace, garden and playground and other M & E plants. | Habitable floor |
| 2.1.2.42 | The habitable height is the height measured from the average level of the ground adjoining the outside of the external walls of the station to the finished floor level of the highest habitable floor. | Habitable height |
| 2.1.2.43 | Headway means the time interval between arrival of consecutive trains of the same service at the platform of a station. | Headway |
| 2.1.2.44 | Heat release rate means energy evolved under a given fire scenario expressed as a function of time. | Heat release rate |

| | | |
|----------|--|--------------------------|
| 2.1.2.45 | The height of station or (where relevant) of part of a station as described in this Standard, means the height of such station or part, measured from the average level of the ground adjoining the outside of the external walls of the station to the level of half the vertical height of the roof of the station or part, or the top of the walls or of the parapet (if any), whichever is the higher. | Height of station |
| 2.1.2.46 | <p>Any occupancy in which the contents or activities include one or more of the following:</p> <ul style="list-style-type: none"> (a) materials that will flame up by themselves without the presence of any fire source below the ignition temperature of 200° C, (b) materials that would produce poisonous, noxious fumes, or flammable vapour, (c) materials that would cause explosions, (d) high hazard occupancies classified under SS CP 52, and (e) highly combustible substances and flammable liquids. | High hazard occupancy |
| 2.1.2.47 | Link load means the number of passengers travelling between two stations over a given period. | Link load |
| 2.1.2.48 | Load bearing wall means a wall that supports any load in addition to its own weight. | Load bearing wall |
| 2.1.2.49 | In the context of this Standard, masonry refers to brick or concrete construction. | Masonry |
| 2.1.2.50 | Non-load bearing wall means a wall that supports no load other than its own weight. | Non-load bearing wall |
| 2.1.2.51 | Boundary presumed to exist for the purpose of this document between buildings/stations on the same site. | Notional boundary |
| 2.1.2.52 | Non-combustible material means any material that neither burns nor gives off any flammable vapour in sufficient quantity to cause ignition when tested for combustibility in accordance with BS 476 Part 4. | Non-combustible material |
| 2.1.2.53 | Non-transit occupancy means an occupancy not related to the operation of railway. | Non-transit occupancy |

| | | |
|----------|--|-------------------------------------|
| 2.1.2.54 | Operation Control Centre is where the authority controls and coordinates the system-wide movement of passengers and trains from which communication is maintained with supervisory and operating personnel of the authority and with participating agencies when required. | Operation Control Centre |
| 2.1.2.55 | The maximum aggregate area of unprotected areas in any side or external wall of a station or compartment as referred to in Cl.2.3.5.2. | Permitted limit of unprotected area |
| 2.1.2.56 | Point of safety means an enclosed fire exit that leads to a safe location outside the structure, or an at-grade point beyond any enclosing structure, or another area that affords adequate protection for passengers. | Point of safety |
| 2.1.2.57 | An exit staircase, exit passageway, lift, chute, duct or other shaft which enables persons or things or air to pass from one compartment to another. | Protected shaft |
| 2.1.2.58 | <p>Wall, floor or other part of the station or trainway which encloses a protected shaft, but not:</p> <p>(a) A wall which also forms part of an external wall, separating wall or compartment wall, or</p> <p>(b) A floor which is also a compartment floor or a floor laid directly on the ground, or</p> <p>(c) A roof.</p> | Protecting structure |
| 2.1.2.59 | Public area means any part of the station that is normally accessible by members of the public. It includes pedestrian linkways connected to the station. | Public area |
| 2.1.2.60 | Railway has the same meaning as in the Rapid Transit Systems Act (No. 29 of 1995). | Railway |
| 2.1.2.61 | Rapid transit system has the same meaning as in the Rapid Transit Systems Act (No. 29 of 1995). | Rapid transit system |
| 2.1.2.62 | Boundary in relation to a side or external wall of a station/building or compartment, including a notional boundary. | Relevant boundary |
| 2.1.2.63 | Includes any dome light, lantern light, skylight or other element intended to admit daylight. | Rooflight |

| | | |
|----------|--|-------------------------------|
| 2.1.2.64 | An enclosed space that is not an enclosed circulation space or a protected shaft or an enclosed space not exceeding 750 mm in depth. | Room |
| 2.1.2.65 | A form of compartmentation that is a part which is separated from another part of the same station by a compartment wall which runs full height of the part and is in one continuous plane. | Separated part (of a station) |
| 2.1.2.66 | A wall separating adjoining buildings/stations. | Separating wall |
| 2.1.2.67 | A lobby located at the entrance to an exit staircase to help to prevent or minimise the entry of smoke into the staircase. | Smoke-stop lobby |
| 2.1.2.68 | Station means a place designated for the purpose of boarding and alighting passengers, including public areas, commercial spaces, ancillary area, and trainway associated with the same structure. <ul style="list-style-type: none"> (a) Stations with Multiple Transit Lines are stations with one or more train platforms and concourse public areas serving different transit lines within a station. (b) Stations with Interchange-link are stations provided with direct transfer between transit lines. (c) Stations connected to Non-transit Occupancy are stations with: <ul style="list-style-type: none"> (i) A pedestrian link connected to non-transit occupancies, and/or (ii) Station entrance integrated with non-transit occupancies. | Station |
| 2.1.2.69 | An open station is a station that is open to the atmosphere and heat and smoke from a train fire are allowed to disperse directly into the atmosphere. An enclosed station is a station or portion thereof that does not meet the requirements of an open station. | Station, open and enclosed |
| 2.1.2.70 | Passenger Service Centre (PSC) means the room located in a station where communication with the Operation Control Centre, trains, passengers and members of the public can be conducted. | Passenger Service Centre |
| 2.1.2.71 | Station platform means the area of a station used primarily for boarding and alighting transit vehicle passengers. | Station platform |

| | | |
|----------|--|---------------------|
| 2.1.2.72 | Trainway means that portion of the guideway in which the transit vehicles operate. | Trainway |
| 2.1.2.73 | Train crush load means the maximum number of passenger capable of occupying a train. | Train crush load |
| 2.1.2.74 | Underground station means a station with its trainway located in the basement storey. | Underground station |
| 2.1.2.75 | In relation to a side or external wall of a station means: <ul style="list-style-type: none"> (a) A window, door or other opening, and (b) Any part of the external wall which has less than the relevant fire resistance required in Cl. 2.3.5. | Unprotected area |
| 2.1.2.76 | An exit staircase or exit ramp serving as required exit from one or more storeys above or below ground level. | Vertical exit |
| 2.1.2.77 | For the purpose of internal surfaces, includes: <ul style="list-style-type: none"> (a) The surface of glazing, and (b) Any part of ceiling which slopes at an angle of 70° or more to the horizontal, but excluding: <ul style="list-style-type: none"> (i) Door frames and unglazed parts of doors, and (ii) Window frames and frames in which glazing is fitted, and (iii) Architraves, cover moulds, picture rails, skirtings and similar narrow members, and (iv) Fitted furniture. | Wall surface |

2.1.3 STATION OCCUPANCY

Station
occupancy

2.1.3.1 The primary purpose of a station is for the use of the transit passengers who normally stay in a station for a period no longer than that necessary to wait for and enter a departing transit vehicle or to exit the station after arriving on an incoming transit vehicle.

2.1.3.2 Ancillary areas in a station are areas housing the electrical and mechanical equipment, and spaces for the use of employees whose work assignments require their presence in the station.

2.1.3.3 - Not in use -

2.1.3.4 One large shop (not exceeding 100m²) and one small shop (not exceeding 15m²) within station are allowed in the public area except platform. For aboveground storeys, there is no restriction on the number of shops if they are not located along the means of egress. Clusters of automatic vending machines are allowed in the public area. Each cluster of vending machines shall consist of not more than two vending machines and clusters of vending machines shall be placed at least 1m apart.

2.1.3.5 Additional commercial spaces shall be permitted in stations provided that these commercial spaces are located on a separate level other than the platform and concourse levels, and comply with the relevant requirements in this Standard.

2.1.3.6 Type of trades and services permitted in station commercial spaces are given in Table 2.1.3.

2.1.4 CABLE INSTALLATION

Cable
installation

The installation of cable in stations and trainways shall comply with the following:

- (a) Cables used shall be either fire retardant or fire resistant. In addition, cables used in underground rapid transit systems shall be of the low-smoke and halogen-free type.
- (b) Fire resistant cables shall comply with SS 299 and fire resistant fibre optic cable shall comply with IEC 60331-25.

- (c) Fire retardant cables shall comply with IEC 60332 Parts 1 & 3 on tests on single and bunched cables under fire conditions.
- (d) Low-smoke and halogen-free cables shall comply with the following requirements:
 - (i) IEC 61034.
 - (ii) When a sample of cable is subjected to the combustion test for the determination of the amount of halogen acid gases (other than hydrofluoric acid) as set out in IEC 60754 - Part 1, and the amount of halogen acid evolved is less than 0.5%, the cable shall be regarded as halogen free.

Cables for fire safety equipment that is required to operate during a fire emergency shall be of fire resistant type.

Exception: Internal cables of control panels/equipment, lifts and its cables, and light fittings.

Table 2.1.3 APPROVED TRADES AND SERVICES IN STATIONS

| CODE | GROUPING | TYPE |
|------|---------------------|--|
| A | General Merchandise | <ul style="list-style-type: none"> • 24 hours convenience store • mini-mart/ provision shop |
| B | Clothing & Shoes | <ul style="list-style-type: none"> • children's wear/accessories • fashion accessories |
| C | Household Supplies | <ul style="list-style-type: none"> • hardware/DIY shop ⁽¹⁾ • home furnishing centre ⁽¹⁾ • household ware/utensils |
| D | Other Retail | <ul style="list-style-type: none"> • arts/antiques • clock • electrical goods • name cards • sports/golf • video library/cassettes/CD/VCD/Laser Disc/DVD • bridal saloon/shops • Chinese medical hall • fruits • perfume • telecommunications |
| E | Financial | <ul style="list-style-type: none"> • bank/auto lobby |
| F | Services | <ul style="list-style-type: none"> • acupuncture • counselling centre • hairdressing/beauty salon • internet service provider • medical/dental clinic • toys/toy collectibles shop • copying and duplicating services • renovation contractor showroom • therapy/osteopathy/chiropractic centre • yoga/martial arts school • video games arcade, computer gaming centre, billiard saloon • child adoption agency • fitness centre • hand phone repair centre • LAN game/internet café ⁽²⁾ • pawnshop • wellness centre/spa |
| G | Food & Beverages | <ul style="list-style-type: none"> • café ⁽²⁾ • snack bars ⁽²⁾ • cake/confectionery/pastry shop ⁽²⁾ • takeaway food and beverages shop ⁽²⁾ • fast food kiosk ⁽²⁾ • titbits/candies/biscuits |

Conditions:

(1) There shall be no selling or storage of paint, solvent, thinner and the like.

(2) For the Food and Beverage outlets, there shall be no open flame.

SECTION 2.2 STATION MEANS OF ESCAPE

ROOT OBJECTIVE

The primary intention of this section is encapsulated in the following statement:-

- R2.2.1 Occupants must be able to escape to a safe place, directly or through a protected exit, before untenable conditions are reached during a fire emergency.

SUB-OBJECTIVES

The following criteria define the conditions necessary to fulfil the intentions of this section:-

- S2.2.1 Provisions for appropriate alternative means of escape.
- S2.2.2 Provisions for adequate capacity of means of escape.
- S2.2.3 Provisions for avoidance of fire occurrence in means of escape.
- S2.2.4 Provisions for adequate protection against transmission of heat and infiltration of smoke into means of escape.
- S2.2.5 Provisions for means of escape appropriate to the occupants' profile and the building's functions and characteristics.
- S2.2.6 Provisions for accessibility of means of escape
- S2.2.7 Provisions for adequate ventilation for means of escape.
- S2.2.8 Provisions for directing occupants to and along means of escape.
- S2.2.9 Provisions for reliable means of escape.
- S2.2.10 Provisions for adequate time for occupant escape to a safe place.
- S2.2.11 Provisions for safe movement of people within the means of escape.

SECTION 2.2 STATION MEANS OF ESCAPE

2.2.1 GENERAL

General

2.2.1.1 The provisions of this section of the Standard shall serve to express the intentions for determining the design, construction, protection, location, arrangement and maintenance of exit facilities to provide safe means of escape for occupants.

2.2.2 OCCUPANT LOAD

2.2.2.1 Except as required in Cl.2.2.2.4 and Cl.2.2.2.5, the occupant load for a transit station shall be:

Occupant load for transit station

- (a) The cumulative occupant load for all platforms in the station calculated in accordance with Cl.2.2.2.2 and Cl.2.2.2.3.
- (b) Based on the peak hour patronage as projected for the design of the transit system.

2.2.2.2 The maximum occupant load for each platform in a station shall be calculated based on:

Maximum occupant load for each platform

- (a) The greater of the a.m. or p.m. peak period loads.
- (b) The simultaneous evacuation of the entraining load and the link load.
- (c) The entraining load and link load for each track shall be based on the entraining load and link load per headway multiplied by the following:
 - (i) The system surge factor, and
 - (ii) In the peak direction, an additional factor of 2 to account for one missed headway.
- (d) The maximum link load at each track shall be the maximum passenger train capacity.

See guide in Appendix A.

2.2.2.3 In multi-level, multi-platform stations, for the purposes of determining required egress capacity in accordance with Cl.2.2.3,

- (a) The maximum occupant load for each platform shall be considered separately, and
- (b) Where several platforms share common means of escape routes, for the purposes of determining required egress capacity in accordance with Cl.2.2.3.7, the occupant load for non-incident platforms not directly impacted by the emergency need only consider the contribution of the normal entraining and detraining loads during the peak period.

2.2.2.4 Where there are commercial spaces and ancillary areas in the station,

- (a) The occupant load for the commercial spaces shall be determined in accordance with Table 2.2.2.4, and
- (b) Occupant load in the ancillary areas (excluding E&M rooms) shall be determined based on 10m² of floor area per person, and
- (c) The occupant load in the commercial spaces and ancillary areas (excluding E&M rooms) shall be included in determining the required egress capacity where means of escape from that floor area converge with means of escape serving other station floor areas.

2.2.2.5 Where stations serve areas with facilities subject to special events such as sports complexes, civic and convention centres, the determination of occupant load for such stations shall consider the potential contribution of passenger volumes not anticipated in normal commuter patronage projections.

Multi-level,
multi-platform
stations

Commercial
spaces and
ancillary areas
occupant load

2.2.3 MEANS OF ESCAPE FROM PLATFORM PUBLIC AREA TO POINT OF SAFETY

2.2.3.1 (a) Each platform public area shall be served by not less than 2 means of escape which are independent of and remote from each other from the platform to the exterior of the station.

Means of escape from platform

(b) The fire safety requirements for the safe evacuation of Persons with Disabilities (PWDs) during fire emergency in the station shall be provided in accordance with APPENDIX J.

Fire Safety Requirements for Persons With Disabilities (PWDs)

2.2.3.2 Stairs and escalators regularly used by passengers need not be enclosed. Such stairs and escalators shall be included in the exit capacity calculation. Except for stairs at station entrance on ground level, handrails for these stairs shall also comply with Cl.2.2.5.6(f).

2.2.3.3 There shall be sufficient exit capacity to evacuate the platform occupant load from the station platform in 4 minutes or less. See APPENDIX B.

2.2.3.4 The station shall be designed to permit evacuation from the most remote point of the platform to any one of the following in 6 minutes or less. (See APPENDIX B).

(a) A point of safety

(b) Concourse level of stations (open stations or where emergency ventilation systems are provided in accordance with Cl.2.6.5). There shall be sufficient exit capacity to evacuate people from the concourse to the external such that there is no waiting time along the egress routes.

Stations with interchange-link and stations connected to non-transit occupancies shall comply with the relevant requirements of Section 2.8.

2.2.3.5 In lieu of the above requirements stipulated in Cl.2.2.3.3 and Cl.2.2.3.4, the station can be designed to permit evacuation from the most remote point of the platform to a point of safety through a fire safety engineering analysis. The fire safety engineering analysis shall demonstrate that during station trainway fire scenario, tenable conditions can be achieved for the safe evacuation of all passengers.

2.2.3.6 Exit capacity shall be calculated in accordance with Cl.2.2.3.7 on the basis of the clear width of means of escape. The clear width of means of escape shall be the minimum width required under Cl.2.2.5.4 plus any additional incremental width available.

2.2.3.7 The capacity of means of escape in person per metre per minute (p/m/min), passenger travel speeds in metres per minute (m/min) shall be as follows:

| Type of means of escape | Capacity (p/m/min) | Travel speed (m/min) | |
|---|--------------------|----------------------|-------------------|
| | | up | down |
| Platforms, corridors and ramps not more than 4% in slope | 80 ⁽¹⁾ | 60 | |
| Stairs, escalators and ramps greater than 4% in slope | 60 ⁽²⁾ | up | 15 ⁽³⁾ |
| | | down | 18 ⁽³⁾ |
| Doors and gates ⁽⁵⁾ | 80 ⁽⁴⁾ | N/A | |
| <p>(1) In calculating the capacity of horizontal means of escape routes with a slope not exceeding 4%, 300mm shall be deducted at each sidewall and 450mm at platform edges.</p> <p>(2) Refer to Cl.2.2.5.12 with respect to the allowable means of escape contribution for escalators.</p> <p>(3) The distance component of travel speed for stairs and stopped escalators is the vertical change in elevation.</p> <p>(4) Measurement of door width shall be in accordance with Cl.2.2.5.13(c).</p> <p>(5) Capacity for fare collection gates shall be in accordance with Cl.2.2.3.8.</p> | | | |

2.2.3.8 Except as required by Cl. 2.2.3.9, the capacity for fare collection gates and turnstiles shall be as follows:

| Type of fare collection equipment | Capacity |
|-----------------------------------|--------------------|
| Gates < 850mm wide | 50 p/min per gate |
| Gates ≥ 850mm wide | 80 p/min per meter |
| Turnstiles | 25 p/min per gate |

Determination of exit capacity

Capacity of means of escape

| | | |
|---------|--|--|
| 2.2.3.9 | Gate-type emergency exits shall be provided for at least 50% of the required means of escape capacity at the fare control line unless the fare collection equipment provides unobstructed exiting under all conditions. | Number of exit staircases or exits |
| 2.2.4 | MEANS OF ESCAPE FROM COMMERCIAL SPACES AND ANCILLARY AREAS | |
| 2.2.4.1 | Except as permitted by Cl.2.2.4.2 and Cl.2.2.4.4, there shall be at least two independent exit staircases or other exits from every storey or part thereof, and the exit staircases or other exits shall be remotely located in accordance with Cl.2.2.5.16. Where a room or space is required to be provided with two exits, each exit shall be of sufficient width to accommodate not less than one half the total occupant load. | Number of exit staircases or exits |
| 2.2.4.2 | Storeys with rooms which are not high hazard occupancies shall be permitted to have a single means of escape where the maximum travel distance on that storey complies with Cl.2.2.4.7. | |
| 2.2.4.3 | Every occupant or tenant shall have direct access to the required exit or exits without the need to pass through the spaces or rooms occupied by other occupants or tenants. | |
| 2.2.4.4 | For rooms located at the buffer areas, the maximum one-way and two-way travel distance shall not exceed 15m and 60m respectively. The determination of travel distance shall be in accordance with Cl.2.2.4.8, and in addition to Cl.2.2.4.8(a), it shall also include a door opening directly to the non-incident trainway. See <i>Diagram 2.2.4.4</i> . | Buffer areas |
| 2.2.4.5 | <p>Where cable chamber or underplatform services ducts have a headroom less than 2000mm,</p> <ul style="list-style-type: none"> <li data-bbox="360 1514 1158 1765">(a) Fixed ladders complying with ANSI A14.3, American National Standard for Ladder - Fixed - Safety Requirements, or BS 5395 Part 3 - Stairs, Ladders and Walkways - Code of Practice for the Design of Industrial Type Stairs, Permanent Ladders and Walkways, shall be acceptable as a means of escape, and <li data-bbox="360 1809 1158 1872">(b) Travel distance on the fixed ladder shall be measured as the vertical distance multiplied by a factor of 2. <li data-bbox="360 1917 1158 1989">(c) Access to fixed ladder at platform level should be adjacent to but separated from the direct path of egress. | Cable chamber and underplatform services ducts |

- (d) Underplatform services ducts shall be provided with at least two means of escape with exits or exit accesses located near the two ends of the underplatform services ducts. Travel distances in Cl.2.2.4.4 and Cl.2.2.4.7 are not applicable to underplatform services ducts, except that one way travel to exit or exit access shall not exceed 15m. It is acceptable that exit accesses are provided in the fire-rated wall that separates the underplatform services ducts into two sections as required by Note 8 of Table 2.5A.
- (e) Non-illuminated exit and directional signs (e.g. sticker type) where used in cable chambers and underplatform service ducts shall comply with SS 508. Non-illuminated exit signs shall be fixed on the exit and/or exit access doors.

2.2.4.6 The capacity of exits, exit staircases, exit passageways, corridors, exit doors and other exit facilities shall be measured in units of width of one half of a metre. The number of persons per unit of width shall be as follows:

| Type of Means of escape | Capacity⁽¹⁾ No. of person per unit of width⁽²⁾ |
|---|---|
| Exit & corridor doors ⁽³⁾ | 80 |
| Staircases | 60 |
| Ramps, corridors & exit passageways | 100 |
| <p>(1) Where a room or space is required to be provided with two exits, each exit shall be of sufficient width to accommodate not less than one half the total occupant load.</p> <p>(2) In the determination of each exit width, fractions of a unit width less than 250mm shall not be credited. Where 250mm or more are added to one or more full units, half of a unit of width shall be credited. Exit width shall be the clear width of the means of escape.</p> <p>(3) Measurement of door width shall be in accordance with Cl.2.2.5.13(c).</p> | |

Capacity

2.2.4.7 The maximum travel distance measured in accordance with Cl.2.2.4.8 shall not exceed the following:

Maximum travel distance

| Occupancy | Means of escape | Maximum travel distance (m) | |
|-------------|-----------------|-----------------------------|----------------|
| | | Sprinkler-ed | Unsprinkl-ered |
| Commercial | One-way | 25 | 15 |
| | Two-way | 60 | 45 |
| Ancillary * | One-way | 30 | 15 |
| | Two-way | 75 | 60 |
| High hazard | One-way | 20 | 10 |
| | Two-way | 35 | 20 |

* See Cl.2.2.4.4 for requirements at buffer areas.
 In a large floor area sub-divided into rooms, corridors and so forth, the travel distance requirements shall be deemed to be satisfied if the “direct distance” does not exceed $\frac{2}{3}$ of the maximum travel distance permitted in this table. Furniture, internal partitions and equipment, e.g. air-handling unit, air-con chiller, tunnel ventilation fans, electrical switch board, in rooms may be ignored in determining the direct distance.

2.2.4.8 Determination of travel distance shall be as follows:

Determination of travel distance

- (a) The travel distance shall be the distance measured from the most remote point in the floor area to a door opening directly to
 - (i) An exit staircase, or
 - (ii) An exit passageway, or
 - (iii) An area of refuge, or
 - (iv) The station public area, or
 - (v) An open exterior space.
- (b) For the purpose of this clause, the most remote point from which the travel distance is measured shall be taken as being 400mm from the enclosure walls of the floor area.

- (c) Where permitted under Cl.2.2.5.6(a)(ii) for exit staircases to be entered without the provision of an exit door, the travel distance shall be measured to a position where the exit door would be installed if otherwise required.

2.2.5 MEANS OF ESCAPE REQUIREMENTS - GENERAL

2.2.5.1 Entry at every storey level to an exit staircase of any station or part of a station of more than four storeys above ground level shall be through:

- (a) An external exit passageway or external corridor. The openings for natural lighting and ventilation to the corridor shall be so located that they face and open upon:

- (i) The external space; or
- (ii) A street, service road or other public space which is open to the sky; or
- (iii) An air-well which opens vertically to the sky and having a minimum width of 6m and a superficial plan area of not less than 93m²;

- (b) A lobby that is separated from the adjoining areas of the station by a wall having a fire resistance of at least 1 hour. The exit door shall have fire resistance of at least half an hour fitted with automatic self-closing device conforming to the requirements of Cl.2.3.9.2. The design of a smoke-stop lobby must be such as not to impede movement of occupants through the escape route. The floor area of a smoke-stop lobby shall be not less than 3m².

A smoke-stop lobby shall be ventilated by:

- (i) Permanent fixed ventilation openings in the external wall of the lobby; such ventilation openings shall have an area of not less than 15 per cent of the floor area of the lobby and located not more than 9m from any part of the lobby, or
- (ii) Mechanical ventilation complying with the requirements in Section 2.6, or

Smoke free approach to exit staircase

External approach

Smoke-stop lobby

- (iii) Permanently fixed ventilation openings of area not less than 15 per cent of the floor area of the lobby and located not more than 9m from any part of the lobby, opening to an open air well which is open vertically to the sky for its full height. The air-well shall have a horizontal plan area of not less than 10m² or 0.1m² for each 300mm of height of the station, whichever is the greater. The minimum width of such space shall not be less than 3m. The enclosure walls to the air well shall have a minimum fire resistance of 1 hour and have no openings other than ventilation openings for the smoke-stop lobby, exit staircase and toilets, or
- (iv) Cross-ventilated corridor having fixed ventilation openings in at least two external walls. The openings to each part of the external walls shall not be less than 50 per cent of the superficial area of the wall enclosing the corridors. No part of the floor area of the corridor shall be at a distance of more than 13m from any ventilation openings.

2.2.5.2 Smoke Free Approach to Exit Staircase and Firemen's Staircase in Basement Occupancy:

- (a) In a station comprising more than 4 basement storeys, entry to exit staircases serving the basement storeys at every basement storey level shall be through smoke-stop lobbies, and
- (b) Entry to firemen's staircases at every basement storey level shall be via fire-fighting lobbies in accordance with Cl.2.4.2.3, and
- (c) Smoke-stop lobbies and fire-fighting lobbies shall be required to comply with the relevant provisions under Cl.2.2.5.1(b) and Cl.2.4.2.3(c) respectively. They shall be mechanically ventilated to comply with the requirements in Section 2.6.

2.2.5.3 When a floor area has access to Area of Refuge in compliance with following requirements in this Clause, the occupant load for which vertical exits are to be accounted for the floor area may be reduced to half when one Area of Refuge is provided and to one-third when two or more Areas of Refuge are provided.

Smoke free approach in basement

Area of refuge and exit reduction

- (a) An Area of Refuge shall be adequate in size to hold the occupant load it receives from the floor area it serves as provision for required exit, in addition to its own occupant load calculated on the basis of 0.3m² per person, and
- (b) An Area of Refuge shall be entered through an external corridor and the room or space or Area of Refuge shall be separated from the corridor by a wall with minimum 1 hour fire resistance, and
- (c) External corridors when used as entry into an Area of Refuge shall conform to the requirements of external exit passageway for minimum width, changes in floor level, roof protection, enclosure on the open side and provision of opening of wall between the room or space and the exit passageway, and
- (d) Exit doors between the room or space or Area of Refuge and the external corridor shall have fire resistance of at least half an hour and fitted with automatic self-closing device to comply with the requirements of Cl.2.3.9.2, and
- (e) Every fire compartment in which exit reduction is permitted in connection with Area of Refuge shall have in addition to exit through the Area(s) of Refuge at least one staircase complying with Cl.2.2.5.6.

2.2.5.4 The minimum clear width of means of escape shall be as follows:

- (a) 2300mm for platforms measured from the platform screen door to any obstruction,
- (b) 2500mm for platforms measured from the platform edge to any obstruction,
- (c) 1750mm for public corridors and ramps,
- (d) 1000mm for non-public corridors and ramps,
- (e) 1000mm for stairs and exit passageways,
- (f) 500mm for fare collection gates,
- (g) 460mm for turnstiles,

Minimum width

| | |
|---|-------------------------|
| <ul style="list-style-type: none"> (h) 850mm for doors and gates, and (i) 500mm for underplatform services ducts. | |
| <p>2.2.5.5 The maximum length of dead-end shall not exceed 15m (non-sprinklered) or 20m (sprinklered).</p> | Dead-end |
| <p>2.2.5.6 EXIT STAIRCASE</p> | |
| <ul style="list-style-type: none"> (a) Internal Exit Staircase <ul style="list-style-type: none"> (i) Except as permitted in Cl.2.2.3.2 an internal exit staircase which serves as the required exit of the station shall be enclosed with construction complying with the provisions of Cl.2.3.8, and (ii) Where an internal exit staircase is directly approached from an external exit passageway or external corridor, it shall not be necessary to provide such enclosure between the staircase and the external exit passageway or external corridor provided no unprotected openings are located within 3m from the exit staircase, and (iii) There shall be no unprotected openings of occupancy area within 1.5m horizontally or within 3m vertically below any part of the ventilation openings located in the external wall of the internal exit staircase. | Internal exit staircase |
| <ul style="list-style-type: none"> (b) External Exit Staircase <ul style="list-style-type: none"> (i) External exit staircase may be used as required exit in lieu of internal exit staircase provided it complies with the requirements of exit staircase, except for enclosure of an internal staircase, and (ii) There shall be no unprotected openings within 3 m horizontally or within 3m vertically below any part of the external exit staircase. | External exit staircase |
| <ul style="list-style-type: none"> (c) All exit staircases shall discharge at ground level directly into a safe exterior open space. | Discharge |
| <ul style="list-style-type: none"> (d) The minimum width and capacity of exit staircases shall be in accordance with Cl.2.2.3.7, Cl.2.2.4.6 and Cl.2.2.5.4. | |

- (e) No part along the direction of escape shall be less than the minimum required width for the stairs and landings.
- (f) Handrails
 - (i) Every exit staircase shall have handrails on both sides, except that staircases that are 1250mm or less in width may have a handrail on one side only, and

Exception: Handrails are not required for any staircase having not more than 5 risers.
 - (ii) Where staircases exceed 2000mm in width, handrails shall be used to divide the staircase into sections of not less than 1000mm of width or more than 2000mm of width, and
 - (iii) Handrail ends shall be returned to the wall or floor or shall terminate at newel posts, and
 - (iv) Handrails that are not continuous between flights shall extend horizontally, at the required height, at least 300mm beyond the top riser and continue to slope for a depth of one tread beyond the bottom riser.
- (g) Where fire-separated exit staircases are provided,
 - (i) There shall be no enclosed useable space within the exit enclosure, including under stairs, and
 - (ii) The exit enclosure shall not be used for any purpose that has the potential to interfere with egress.
- (h) Staircases shall be provided with a sign not smaller than 300mm x 300mm within the stairwell at each storey landing. The sign shall contain the following information in the order as follows:
 - (i) The storey number, at least 125mm in height
 - (ii) An identification of the staircase in alphabet and/or number, at least 25mm in height.

Handrails

No useable space in exit enclosure

Stair identification sign

- (iii) The sign shall be located such that it is visible when the door is in the open position and also visible to any person moving up or down the staircase.
- (iv) The letters and numbers on the sign may be of any colour that shall contrast with the background colour.

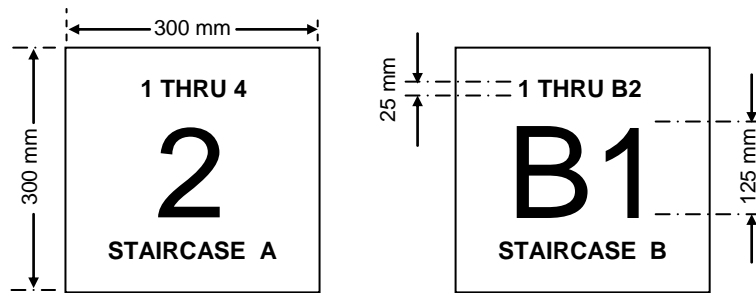

- (i) All exit staircases shall be ventilated by fixed openings in the external walls, such openings being of area not less than 10 per cent of the floor area per floor of the staircase, or mechanically ventilated to comply with the requirements in Section 2.6. Exit staircase and occupancy area shall not share the same airwell or void for lighting and ventilation.
- (j) In any station of which the habitable height exceeds 24m, any internal exit staircases without provision for natural ventilation shall be pressurised to comply with the requirements in Section 2.6. In a station comprising more than four basement storeys, the exit staircase connecting to the fire-fighting lobby shall be pressurised.

2.2.5.7 SCISSORS EXIT STAIRCASE

- (a) Where two separate internal exit staircases are contained within the same enclosure, each exit staircase shall be separated from the other by non-combustible construction having fire resistance for a minimum period equal to that required for the enclosure, and
- (b) Such scissors exit staircases shall comply with all applicable provisions for exit staircase under Cl. 2.2.5.6.

Ventilation

Pressurisation

Scissors exit staircase

2.2.5.8 BASEMENT EXIT STAIRCASE

Basement exit staircase

- (a) Any exit staircase which serves a basement storey of a station shall comply with all the applicable provisions for exit staircase under Cl.2.2.5.6, and
- (b) Such exit staircase shall not be made continuous with any other exit staircase which serves a non-basement storey of the station, and
- (c) Basement exit staircases which are vertically aligned with the exit staircases of non-basement storeys shall be separated from such other exit staircases by construction having fire resistance for a minimum period equal to that required for the enclosure.

2.2.5.9 SPIRAL STAIRCASE

Spiral staircase

- (a) Spiral staircases shall not serve as required exits except that external unenclosed spiral staircases when built of non-combustible materials and having a tread length of at least 750mm may serve as required exits from mezzanine floors and balconies or any storey having an occupant load not exceeding 25 persons, and
- (b) Such spiral staircases shall be not more than 10m high, and
- (c) Spiral staircases shall comply with the applicable requirements of Cl. 2.2.5.6.

2.2.5.10 EXIT RAMP

Exit ramp

- (a) Internal and external exit ramps may be used as exits in lieu of internal and external exit staircases subject to compliance to the applicable requirements of Cl.2.2.5.6, and
- (b) The minimum width and capacity of exit ramp shall be in accordance with Cl. 2.2.3.7, Cl. 2.2.4.6 and Cl. 2.2.5.4.
- (c) The slope of such exit ramps shall not be steeper than 1 in 12, and

- (d) Exit ramps shall be straight with changes in direction being made at level platforms or landings only, except that exit ramps having a slope not greater than 1 in 12 at any place may be curved, and
- (e) Level platforms or landings shall be provided at each door opening into or from an exit ramp, and
- (f) Level platforms or landings shall be provided at the bottom, at intermediate levels where required and at the top of all exit ramps, and
- (g) The minimum width of a platform or landing and length shall be not less than the width of the ramp, except that on a straight-run ramp, the length of the level platform or landing need not be more than 1m, and
- (h) All exit ramps shall be provided with non-slip surface finishes, and
- (i) Exit ramps serving as means of escape to only one basement storey need not be protected by enclosure walls.

2.2.5.11 EXIT PASSAGEWAYS

- (a) Exit passageways that serve as a means of escape or required exits from any station or storey of a station shall have the requisite fire resistance as specified under Cl.2.3.3.
- (b) Internal exit passageway
 - (i) An internal exit passageway which serves as required exit of the station shall be enclosed with construction complying with the provisions of Cl.2.3.3, and
 - (ii) The enclosure walls of an exit passageway shall have not more than two exit doors opening into the exit passageway, and
 - (iii) Exit doors opening into an exit passageway shall have fire resistance rating as required for exit doors opening into exit staircases, fitted with automatic self-closing device and complying with the requirements of Cl.2.3.9.2 for fire resisting doors, and

Internal exit passageway

- (iv) The minimum width and capacity of exit passageway shall comply with the requirements as provided in Cl.2.2.3.7, Cl.2.2.4.6 and Cl.2.2.5.4, and
 - (v) Changes in level along an exit passageway requiring less than two risers shall be by a ramp complying with the provisions under Cl.2.2.5.10, and
 - (vi) If the exit staircase which connects to the internal exit passageway is pressurised, the internal exit passageway shall not be naturally ventilated but shall be mechanically ventilated, and it shall be pressurised to comply with the requirements in Section 2.6.
- (c) External exit passageway
- (i) An external exit passageway may be used as a required exit in lieu of an internal exit passageway, provided that the external wall between the exit passageway and the rest of the floor space may have ventilation openings of non-combustible construction, fixed at or above a level 1.8m, measured from the finished floor level of the passageway to the sill level of the openings and such ventilation openings shall be located not less than 3m from any opening of an exit staircase, and
 - (ii) An external exit passageway may not be subjected to the limitations of a maximum of two exit doors opening into the exit passageway, and
 - (iii) An external exit passageway may be roofed over provided the depth of the roofed over portion shall not exceed 3m to avoid smoke logging, and
 - (iv) An external exit passageway may be enclosed on the open side by only a parapet wall or solid balustrade of not more than 1m in height, and
 - (v) Exit doors opening into an external exit passageway shall have fire resistance for at least half an hour and fitted with automatic self-closing device.

External exit
passageway

(d) Ventilation

- (i) Except as permitted by sub-clause (ii), all internal exit passageways shall be naturally ventilated by fixed ventilation openings in an external wall, such ventilation openings being not less than 15 per cent of the floor area of the exit passageway, and
- (ii) Internal exit passageways that cannot be naturally ventilated shall be mechanically ventilated to comply with the requirements in Section 2.6.

Ventilation

2.2.5.12 ESCALATORS

- (a) Escalators not fire-separated from the public floor area shall be considered as contributing to the means of escape capacity.
- (b) Escalators shall not account for more than 50% of the exit capacity at any one level.
- (c) Because of the possibilities of maintenance or malfunction, one escalator at each station shall be considered as being out of service in calculating egress requirements. The escalators chosen shall be the one having the most adverse effect upon exiting capacities.
- (d) The width of the escalator shall be the width of the step tread.
- (e) Escalators shall be provided with flat steps at landings which increase in number proportionally with the rise of the escalator as follows:

| Rise | Number of Flat Steps |
|-----------|----------------------|
| Up to 6 m | Not less than 2 |
| 6 – 18 m | Not less than 3 |
| Over 18 m | Not less than 4 |

- (f) Where operating in the direction of exit travel, escalators shall be permitted to be left in the operating mode during evacuation.

Escalators

- (g) Where escalator can be operated in the direction opposite to exit travel, the escalator shall be provided with stopping devices:
 - (i) At the escalator, and
 - (ii) At the PSC and/or the OCC, except that the escalator shall be fully visible at the remote control location.

2.2.5.13 DOORS AND EXIT DOORS

- (a) Exit doors shall be capable of being opened manually, and
- (b) Exit doors which are required to have fire resistance rating shall comply with the relevant provisions for fire resisting doors under Cl.2.3.9.2, and
- (c) In determining the egress width of a doorway for the purpose of calculating capacity, only the clear width of the doorway when the door is in the full open position shall be measured. The measurement of width shall be the clear width between the edge of the door jamb or stop and the surface of the door when kept open at an angle of 90 degrees in the case of a single door; and in the case of a double door opening, between the surface of one leaf to the other when both leaves are kept open at an angle of 90 degrees. See *Diagram 2.2.5.13(c)*, and
- (d) Doors and exit doors shall open in the direction of exit travel:
 - (i) When used in an exit or protected enclosure, or
 - (ii) When serving a high hazard area, or
 - (iii) When serving a room or space with more than 50 persons, and
- (e) (i) Exit doors opening into exit staircases and exit passageways shall not impede the egress of occupants when such doors are swung open in accordance with *Diagram 2.2.5.13(e)*, and

Doors and exit doors

Measurement of door width

- (ii) All exit access doors which open into the corridor shall not hinder movement of occupants. The corridor's clear width shall at least remain to be half of the required clear width as stipulated in Cl. 2.2.5.4 when such door(s) is swung open.

Exception: Exit access doors of plantrooms in buffer areas.

- (f) Fire door to protected staircase and smoke-stop/fire-fighting/fire lift lobby shall be constructed to incorporate a vision panel. The vision panel shall have a clear view size of 100mm width by 600mm height. The vision panel shall have the requisite fire resistance rating and shall not turn opaque when subject to heat. The vision panel shall be located with the bottom edge not higher than 900mm and the top edge lower than 1500mm measured from the finished floor level, and

Vision panel

- (g) Revolving doors shall not be used as exit doors for required exits, and

- (h) Where exit doors in a means of escape are used in pairs,

- (i) Approved automatic flush bolts shall be provided, and

- (ii) The unlatching of any leaf shall not require more than one operation, and

- (i) Latched exit doors in a means of escape from an area having an occupant load of 100 persons or more shall be equipped with approved panic exit device. The panic exit device shall operate to open the door when a pressure is applied on the bar in the direction of travel and be appropriately marked "Push Bar To Open" in letters not less than 50mm high, and

Panic exit device

- (j) Where doors located in the required means of escape path are operated by power upon the approach of a person, the doors shall automatically opened and remained at the fully open position,

Electrically operated doors in means of escape path

- (i) Upon activation of the station's fire alarm, or

- (ii) In the event of a loss of power to the door.

(k) Where electrically locked doors are located in the required means of escape path,

(i) The doors shall be unlocked:

- upon activation of the station's fire alarm
- in the event of loss of power to the lock
- upon activation of a manually operated switch by authorized personnel manning the Passenger Service Centre or, in the absence of which, at the OCC,

After unlocking, the lock shall be designed to be reactivated only at the manual control switch, and where activated by the station's fire alarm, after the station's fire alarm has been reset.

Exception: Doors to equipment rooms not forming part of the means of escape for the public shall not be unlocked by activation of the station's fire alarm and the manually operated switch in PSC/OCC.

(ii) A break-glass manual release device

- shall be installed 1.2m vertically above the floor and within 1.5m of the exit door jamb on the egress side, and
- when operated, shall result in direct interruption of power to the lock independent of the control system electronics, and

(iii) Signage with shape, dimension, colour scheme, lettering style and lettering sizes complying with SS 508 shall be installed

- On the egress side of doors reading "Emergency Exit. Door will automatically unlock in case of fire/emergency", and
- On the break-glass manual release device reading "EMERGENCY DOOR RELEASE".

Electrically locked doors in means of escape path

2.2.5.14 FARE COLLECTION GATES AND TURNSTILES

- (a) Fare collection gates, when deactivated, shall provide a minimum clear width in accordance with Cl.2.2.5.4(f). Consoles shall not exceed 1100mm in height.
- (b) A turnstile-type fare collection gate shall provide a minimum clear width in accordance with Cl.2.2.5.4(g). Maximum height of the turnstile bar shall not exceed 1000mm.
- (c) Fare collection gates and turnstiles shall be designed to be deactivated automatically in the following events:
 - (i) A loss of power to the lock
 - (ii) Upon activation of a manually operated switch accessible to authorized personnel within the PSC, in the absence of which, at the OCC.

After deactivation, the fare collection gates and turnstiles shall be designed to be reactivated only at the manual control switch.

- (d) When deactivated,
 - (i) Freewheel or open in the exit direction, and
 - (ii) Permit movement of passengers in the exit direction regardless of any failure to operate properly.

2.2.5.15 Where gate-type emergency exits are provided in complying with Cl.2.2.3.9, they shall be electrically operated and shall be designed so that they will be deactivated in accordance with Cl.2.2.5.14(c).

2.2.5.16 Where more than one exit is required from an area, a room or a compartment, such exits shall be remotely located from each other and shall be arranged and constructed to minimise the possibility that more than one can be blocked by any one fire or other emergency condition. The following shall be complied with:

Fare collection gates and turnstiles

Gate-type emergency exits at Fare control line

Two-way escape (Remoteness of exits)

- (a) If two exits or exit access doors are required, they shall be placed at a distance from one another equal to or not less than half the length of the maximum overall diagonal dimension of the compartment or area to be served, measured in a straight line between the furthest edges of the exit doors or exit access doors (see *Diagram 2.2.5.16(a)(i) to (a)(v)*). If the distance between the 2 exits is less than half the length of the maximum overall diagonal dimension of the compartment or area to be served, it shall be considered as a one-way escape arrangement.
- (b) In rooms or compartments protected throughout by an approved automatic sprinkler system which complies with the requirements of Section 2.5, the minimum separation distance between two exits or exit access doors measured in accordance with Cl. 2.2.5.16(a) shall be not less than one third the length of the maximum overall diagonal dimension of the compartment or area to be served.
- (c) Where exits are inter-connected by a corridor, exit separation shall be permitted to be measured along the line of travel within the exit access corridor. The exit access corridor connecting the exits shall be protected by minimum 1-hour fire rated enclosures. Doors opening into this corridor shall have minimum ½-hour fire resistance rating (see *Diagram 2.2.5.16(c)*).

2.2.5.17 Exits shall be provided with artificial lighting facilities to the satisfaction of the requirements in Section 2.7.

Exit lighting

2.2.5.18 The location of every exit on every floor shall be clearly indicated by exit sign and directional signs to comply with the requirements in Section 2.7.

Exit and directional sign

2.2.5.19 Photo luminescent marking

Photo luminescent marking / tape to guide occupants along evacuation routes to appropriate exit shall be provided:

- (a) along internal walls and / or floors of the exit staircase, smoke-stop lobby and fire-fighting lobby;
- (b) on the doors of smoke-stop lobby, fire-fighting lobby and exit staircase;
- (c) along corridor with exit directional signs.

Omission of photo luminescent marking/tape is permitted on the following conditions:

- (i) the emergency power supply of the exit lightings, exit signs and directional signs in the above locations shall be self-contained battery pack (single point system) in compliance with SS 575, or central battery supply backed up by stand-by generator or dual electric feeder; and
- (ii) there shall be at least 2 emergency luminaires in the smoke stop lobby, fire fighting lobby and corridor with exit directional signs, such that no part of such spaces shall be left in total darkness should there be failure of anyone of the emergency luminaires; and
- (iii) there shall be at least one emergency luminaire at every exit staircase landing.

Note: Single point (emergency lighting) system - A system of emergency lighting employing self-contained emergency luminaires.

Photo luminescent marking

Table 2.2.2.4 OCCUPANCY LOAD - COMMERCIAL SPACES

| FUNCTIONAL SPACES | OCCUPANCY LOAD (m²/person) |
|------------------------------|--|
| Reception Area | 3.0 |
| Lobby/Corridors | * |
| Fixed Corridors | * |
| Waiting Area/Visitors Lounge | 3.0 |
| Atrium Floor/Concourse | 3.0 |
| Exhibition/Promotion Area | 1.5 |
| Shop Floor | 5.0 |
| Showroom | 5.0 |
| Supermarket/Bazaar | 5.0 |
| Department Store | 5.0 |
| Admin. Office | 10.0 |
| Toilets/Staff Rest Room | * |
| Storage | 30.0 |
| Mechanical Plant Room | 30.0 |
| Classroom | 1.5 |

* - not considered for occupant load calculation

Diagram 2.2.4.4 - Means of escape for rooms located at buffer areas

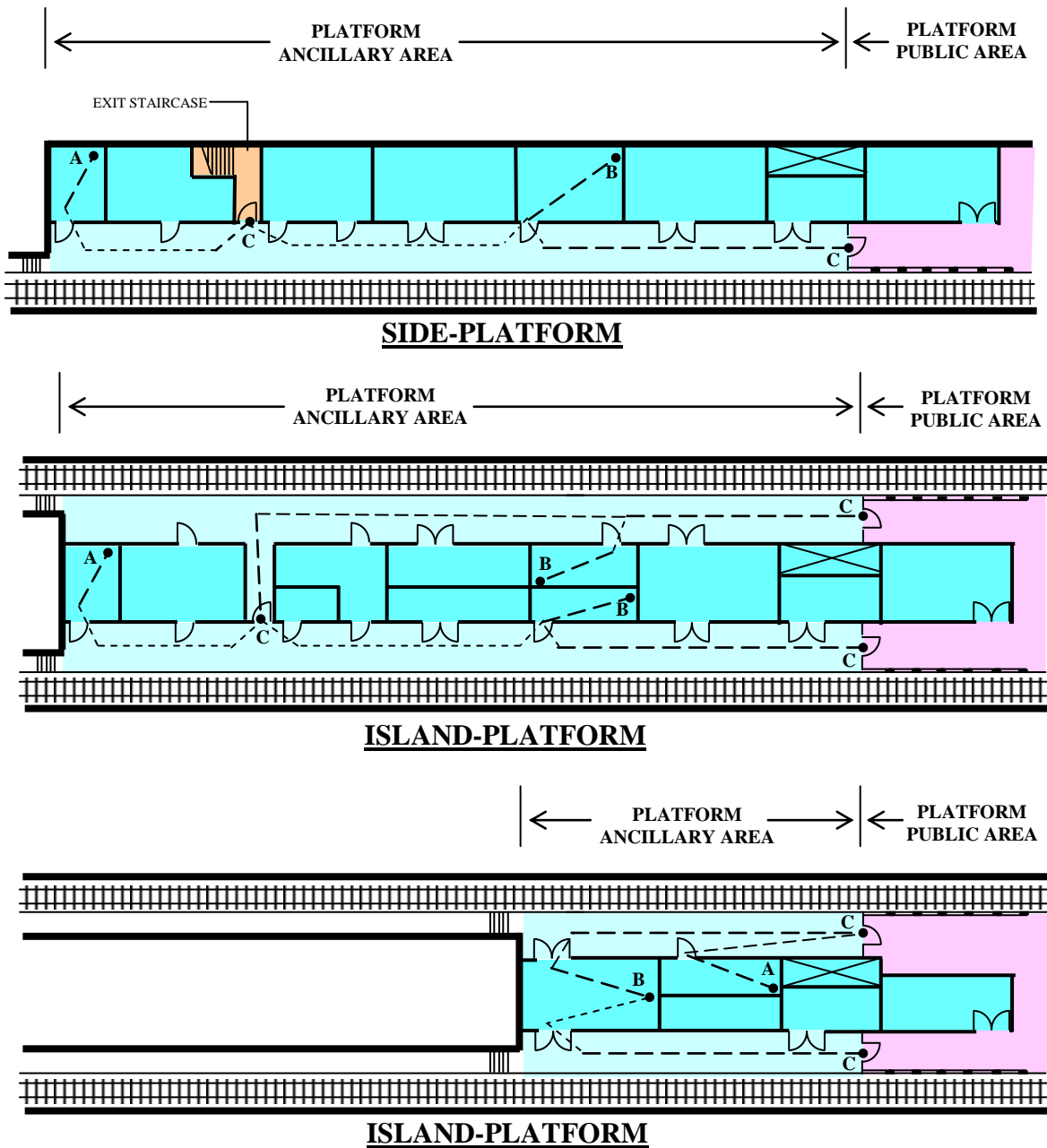

Travel distance from A to C \leq 15 m (One-way).
 Travel distance from B to C \leq 60 m (Two-way).

Diagram 2.2.5.13(c) - Measurement of door width

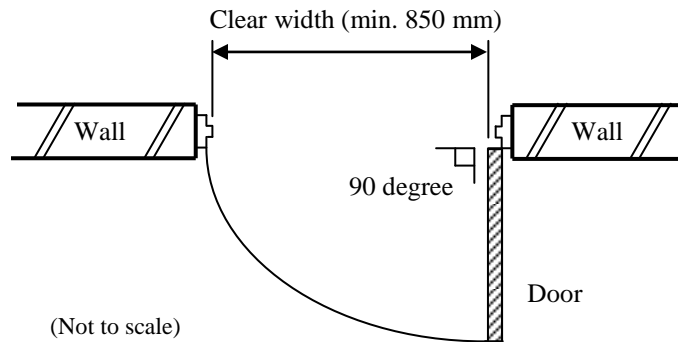

SINGLE LEAF DOOR

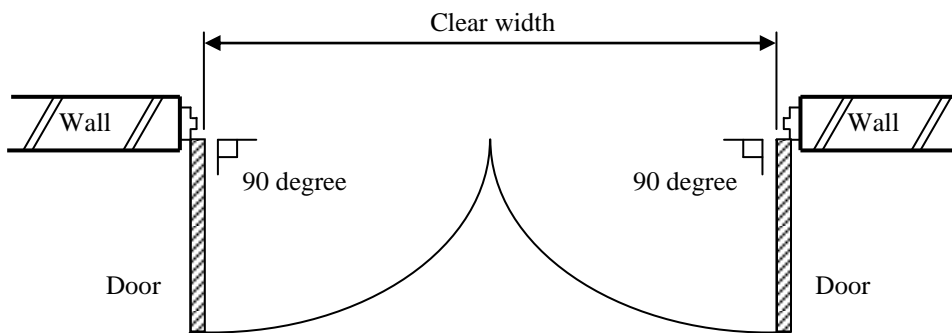

DOUBLE-LEAF DOOR

- Automatic flush bolt shall be provided. See Clause 2.2.5.13(h).
- For fire doors, automatic self-closing devices on both door leaves and sequence selector shall be provided.

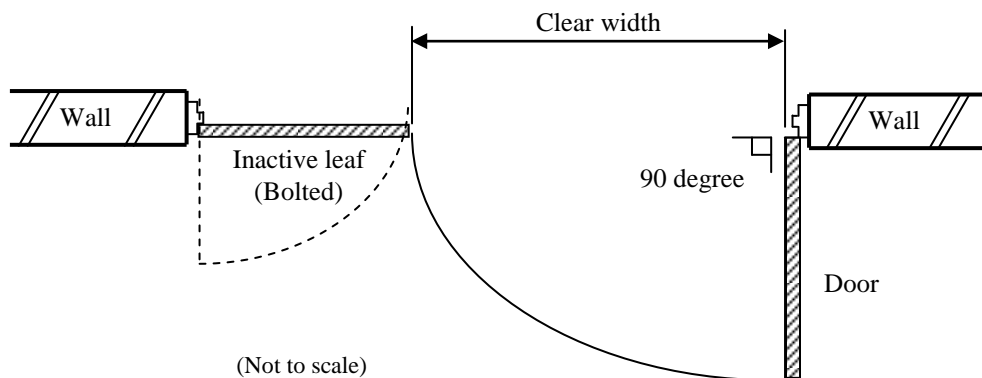

DOUBL-LEAF DOOR

For fire doors, see hardware and other requirements for door in Clause 2.3.9.2(h).

Diagram 2.2.5.13(e) - Exit doors shall not impede the egress of occupants when such doors swing open

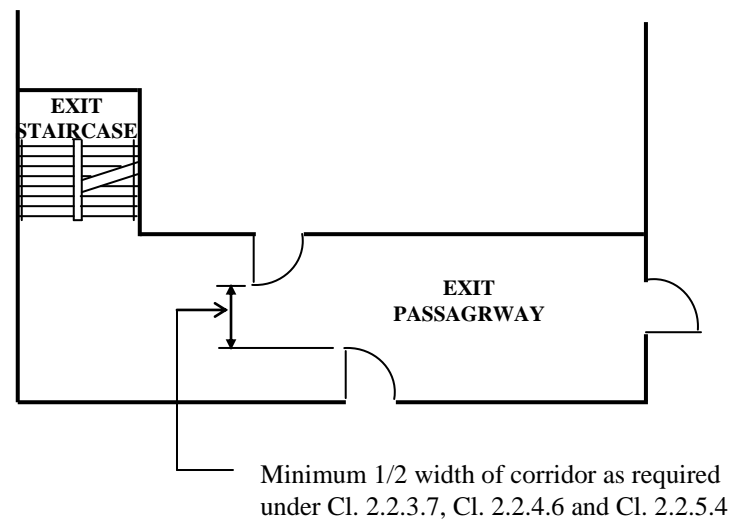
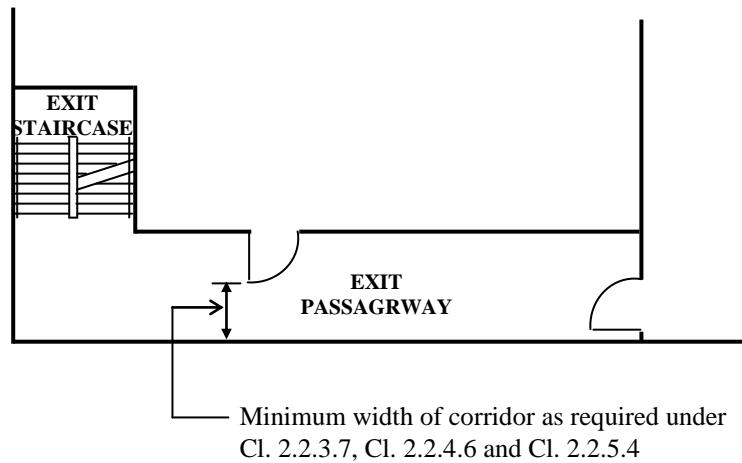
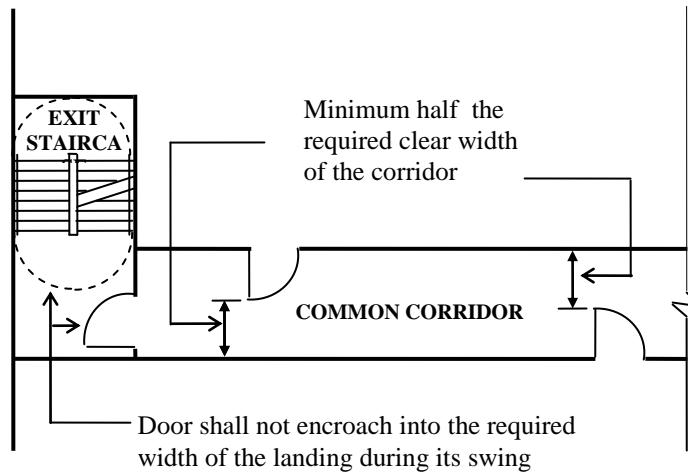

Diagram 2.2.5.16(a)(i) to (a)(iv) - Remoteness of exit staircase

Arrangement of exits

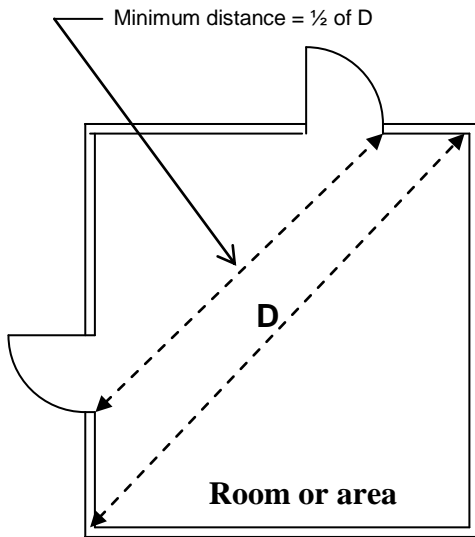

Diagram 2.2.5.16(a)(i)

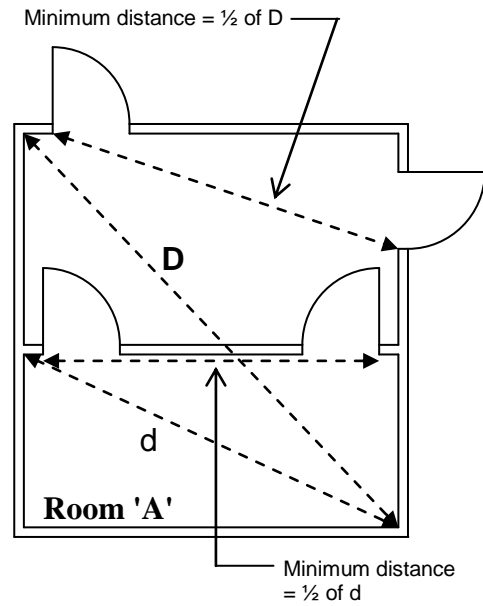
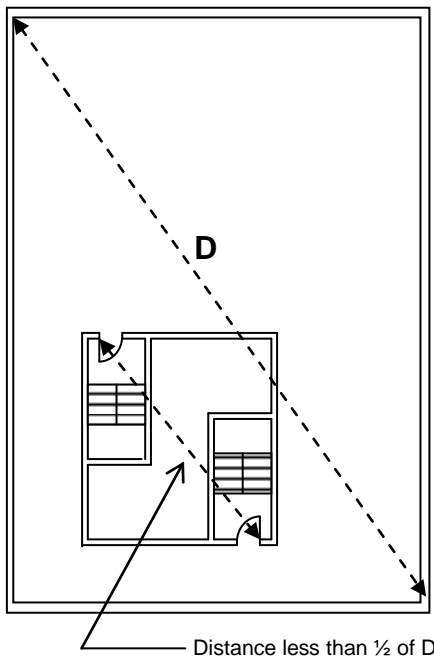
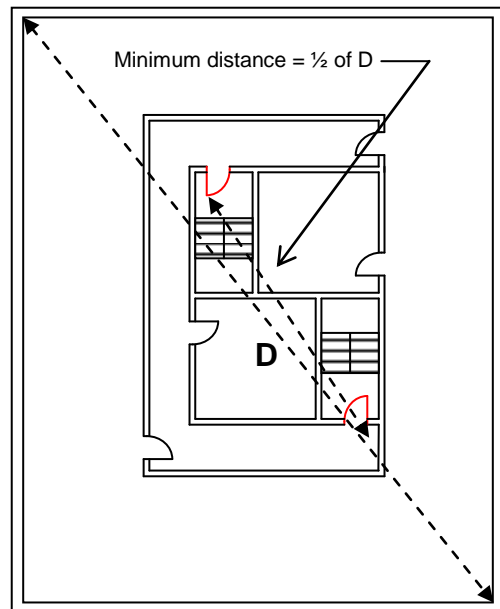

Diagram 2.2.5.16(a)(ii)



One-way escape arrangement
The distance between the two staircases is less than half the length of the maximum overall diagonal dimension of the area

Diagram 2.2.5.16(a)(iii)



Two-way escape arrangement
The distance between the two staircases is at least half the length of the maximum overall diagonal dimension of the area

Diagram 2.2.5.16(a)(iv)

Diagram 2.2.5.16(a)(v) - Remoteness of exits

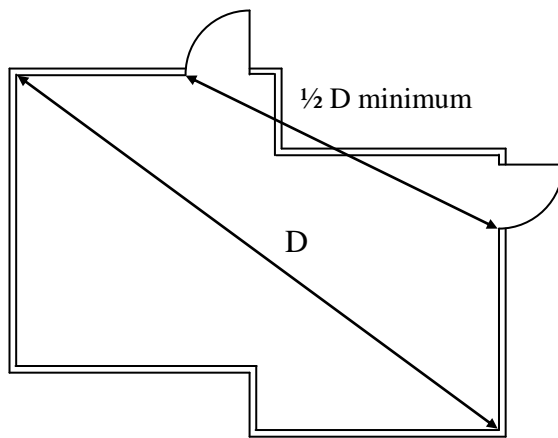

Not to Scale

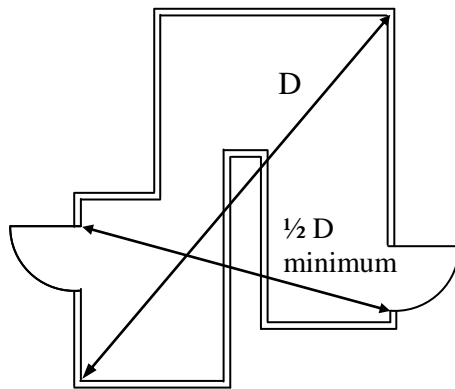

Not to Scale

Diagram 2.2.5.16(c) - Remoteness of exits staircases

Arrangement of exit staircases

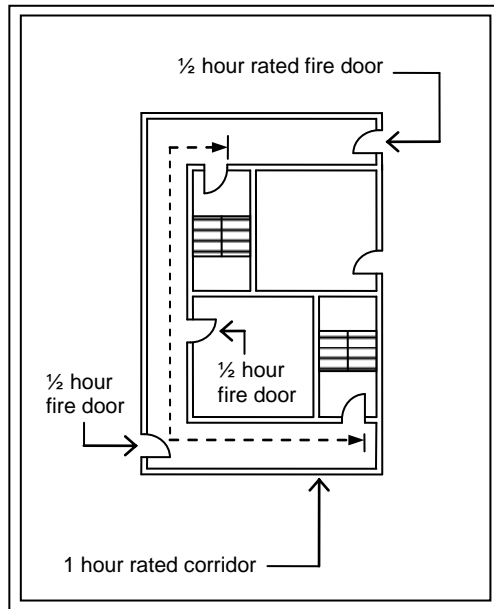

Remoteness of exits is measured along the 1-hour rated corridor with 1/2 hour fire doors.

SECTION 2.3

STATION STRUCTURAL FIRE PRECAUTIONS

ROOT OBJECTIVES

The primary intentions of this section are encapsulated in the following statements:-

- R2.3.1 Prevent the untimely collapse of any part of the station structure due to the effects of fire that would affect the safe egress of the station occupants.
- R2.3.2 Avoid the spread of fire from and to adjacent buildings.
- R2.3.3 The station shall remain structurally stable to allow adequate time for fire-fighters to conduct their fire-fighting and rescue operations.

SUB-OBJECTIVES

The following criteria define the conditions necessary to fulfil the intentions of this section:-

- S2.3.1 Provisions of elements of structure with appropriate fire resistance with respect to:-
 - (i) the fire severity; and
 - (ii) fire-fighting and rescue operations; and
 - (iii) the occupant evacuation time; and
 - (iv) enclosure characteristics and configurations of the station; and
 - (v) the height and depth of the station; and
 - (vi) occupancy characteristics; and
 - (vii) different levels of fire risk.
- S2.3.2 The construction and use of building materials should be of the type and method appropriate to the intended performance.
- S2.3.3 Provisions for adequate measures to limit the development of fire.

- S2.3.4 Provisions for prevention of spread of fire from and to areas of different hazard occupancy.
- S2.3.5 Provisions for prevention of spread of fire from storey to storey.
- S2.3.6 Provisions for prevention of spread of fire to adjacent buildings.
- S2.3.7 Provisions to limit fire and smoke spread in concealed spaces.
- S2.3.8 Provisions for the protection of station fire safety systems to enable their proper functioning during a fire emergency.
- S2.3.9 Provisions for measures to prevent premature collapse of any part of the station structure due to fire that would affect the safe egress of station occupants.
- S2.3.10 Provisions for measures to maintain the stability of the elements of structure for the duration required for fire-fighting and rescue operations.

SECTION 2.3 STATION STRUCTURAL FIRE PRECAUTIONS

2.3.1 GENERAL

General

2.3.1.1 The purpose of this section of the Standard is to stipulate requirements to minimise the risk of spread of fire between adjoining stations/buildings by separation, prevent the untimely collapse of stations in the event of fire by the provision of a stable and durable form of construction and prevent the spread of fire between specified parts of the stations by the division of such stations into compartments.

2.3.2 PROVISION OF COMPARTMENT WALLS AND COMPARTMENT FLOORS

2.3.2.1 Any station which has:

Compartment size - floor area & cubical extent

- (a) Any storey the floor area of which exceeds that specified as relevant to a station of that height in column (2) of Table 2.3.2A, or
- (b) A cubic capacity which exceeds that specified as so relevant in column (3) of Table 2.3.2A,

shall be divided into compartments by means of compartment walls and compartment floors so that -

- (i) No such compartment has any storey the floor area of which exceeds the area specified as relevant to the station in column (2) of the Table, and
- (ii) No such compartment has a cubic capacity which exceeds that specified as relevant in column (3) of the Table.

Exception: Size limitation of compartment shall not apply to the public area below ground level. Compartment size for public area below ground level shall comply with Cl. 2.3.2.4(e).

| | | |
|---------|---|--|
| 2.3.2.2 | In computing the cubical extent of compartments in shops and similar premises, a height of 4m may be used where the actual height exceeds that figure, provided that this rule for measurement shall not be applied when a compartment comprises more than one storey or contains mezzanine or galleries. | Cubical extent for compartment exceeding 4 m in height |
| 2.3.2.3 | Compartmentation by Height | Compartmentation by height |
| (a) | In any compartment up to a habitable height of 24m, no compartment shall comprise more than 3 storeys. | |
| (b) | In any station which exceeds 24m in habitable height, no compartment shall comprise more than one storey for compartments at storey level exceeding 24m above average ground level. | |
| 2.3.2.4 | The following situations shall require compartmentation by provision of compartment walls and/or compartment floors: | |
| (a) | Transit and non-transit occupancies shall have a fire separation of at least 2 hours. Stations connected to non-transit occupancies shall comply with the relevant requirements of Section 2.8. | Separation of transit and non-transit occupancies |
| (b) | All public areas shall have a fire separation of at least 2 hours from ancillary areas. | Separation of public and ancillary areas |
| | Exception 1: Fire separation shall not apply to Passenger Service Centre, station master room, ticketing office and enclosures housing ticket vending machines. | |
| | Exception 2: Platform public areas need not be fire separated from the trainway and buffer areas. | |

- (c) Commercial spaces shall be compartmented by having not less than 2 hours fire resistance construction. If sprinkler protection is provided, the fire resistance rating can be reduced to at least 1 hour.

Separation of commercial spaces

Exception 1: For additional commercial space make up of a group of shops (permitted under Cl. 2.1.3), fire separation is required only at the periphery around the large commercial space as shown in *Diagram 2.3.2.4(c)*.

Exception 2: Where commercial spaces at the ground level of station entrances of underground stations are not located along the station's means of egress, and smoke generated from a fire in the commercial spaces will not be drawn into the station, these commercial spaces are not required to be compartmentalised.

Exception 3: Where commercial spaces in above ground stations are not located along the station's means of egress, and are located more than 6m from the edge of the guideway, these commercial spaces are not required to be compartmentalised.

Exception 4: That parts of the external wall and roof of commercial spaces in aboveground stations not located along the station means of egress and more than 6m from the edge of the guideway, are not required to be fire-rated.

- (d) For aboveground stations, commercial spaces and ancillary areas located beneath and within 3m of the trainway shall be compartmentalised from the viaduct and its supporting structure by a fire resistance construction of not less than 2 hours. If sprinkler protection is provided, the fire resistance rating can be reduced to at least 1 hour.

Exception: Office, Passenger Service Centre, station master room and ticketing machine rooms located beneath and within 3m of the trainway shall only have a fire-rated roof with a fire resistance rating of not less than 2 hours. If sprinkler protection is provided, the fire resistance rating can be reduced to at least 1 hour.

- (e) In any compartment below ground level, no compartment shall comprise more than one storey, except for the public area which shall not exceed 3 storeys per compartment.

- (f) Special purpose rooms shall be compartmentalised in accordance with Table 2.5A.

- (g) Areas of Special Hazard

- (i) Transformer rooms, generator rooms, and any other area of special high risk shall be separated from other parts of the station by compartment walls and floors having fire resistance of not less than 4 hours provided that transformer rooms which do not utilise flammable liquid shall be required to be separated from other parts of the station by compartment walls and compartment floors having fire resistance of not less than 2 hours, and

- (ii) Rooms housing transformer containing flammable liquid and generator rooms shall be located against an external wall.

Exception: Generator rooms containing non-flammable liquids in underground stations are not required to be located against an external wall.

Ancillary areas located beneath and within 3 m of the trainway

Basement floors

Special purpose rooms

Areas of special high risk in a station

(h) Coldroom

Where the enclosure to a coldroom is constructed partly or wholly with combustible materials, a separate outer layer of non-combustible construction having minimum 2-hour fire resistance rating shall be provided to compartmentalise the coldroom enclosure from other areas. The door to such an enclosure shall have minimum 1-hour fire resistance rating. However, the provision of fire resistance door is not required if the coldroom is located in a sprinkler protected building. Provision of the fire resisting outer layer enclosure to the coldroom(s) would not be required if the coldroom(s) is located within a room space that is separated from other parts of the station by compartment walls/floor having the necessary fire resistance rating required under Cl.2.3.2.4 and has an aggregate cubicle extent (measured internally) of not more than 30 cubic metre, and storage materials in the coldroom(s) shall not contain any highly flammable chemicals.

Coldroom

2.3.3 **FIRE RESISTANCE OF ELEMENTS OF STRUCTURE**

2.3.3.1 Subject to any expressed provision to the contrary, any element of structure shall be constructed of non-combustible materials and to have fire resistance for not less than the relevant period specified as follows:

Minimum periods of fire resistance

- (a) The fire resistance of elements of structure for aboveground stations shall be not less than 2 hours.
- (b) The fire resistance of elements of structure for underground stations shall be as follows:
 - (i) Structure member forming part of the structural frame of a station – 4 hours
 - (ii) Load bearing wall or load bearing part of a wall – 4 hours
 - (iii) Floor – 4 hours
 - (iv) Separating wall – 2 hours
 - (v) Compartment wall – 2 hours
 - (vi) Structure enclosing a protected shaft – 2 hours



- (c) Where there are habitable floors directly above a trainway within an above-ground station, the fire resistance of elements of structure around the trainway within the station shall be not less than 4 hours as shown *Diagram 2.3.3.1(c)*.

2.3.3.2 Nothing in Cl.2.3.3.1 shall apply to any part of any external wall which is non-loadbearing and may, in accordance with Cl.2.3.5 be an unprotected area.

Exemption for non-loadbearing external walls

2.3.3.3 In the case of a station consisting of a first storey and one or more basement storeys, nothing in Cl. 2.3.3.1 shall apply to any element of structure which forms part of the first storey and consists of:

Exemption for single storey structure

- (a) A structural frame or a beam or column, provided that any beam or column (whether or not it forms part of a structural frame) which is within or forms part of a wall, and any column which gives support to a wall or gallery, shall have fire resistance of not less than the minimum period, if any, required by this standard for that wall or gallery, or
- (b) An internal loadbearing wall or a loadbearing part of a wall, unless that wall or part is, or forms, part of a compartment wall or a separating wall, or forms part of the structure enclosing a protected shaft or supports a gallery, or
- (c) Part of an external wall which does not support a gallery and which may, in accordance with Cl.2.3.5 be an unprotected area.

2.3.3.4 The interpretation and application of Cl.2.3.3 shall be as follows:

- (a) Subject to the provisions of sub-cl. (b) and any other expressed provision to the contrary, any reference to a station of which an element of structure forms a part means the station or (if the station is divided into compartments) any compartment of the station of which the element forms a part, and

Interpretation and application of Cl. 2.3.3

- (b) Any reference to height means the height of a station, but if any part of the station is completely separated throughout its height both above and below ground from all other parts by a compartment wall or compartment walls in the same continuous vertical plane, any reference to height in relation to that part means the height solely of that part, and
- (c) If any element of structure forms part of more than one station or compartment and the requirements of fire resistance specified in Cl. 2.3.3.1 in respect of one station or compartment differ from those specified in respect of any other station or compartment of which the element forms part, such element shall be so constructed as to comply with the greater or greatest of the requirements specified.
- (d) If any element of structure is required to be of non-combustible construction, the measure of fire resistance rating shall be determined by the part which is constructed wholly of non-combustible materials.

2.3.3.5 In determining the fire resistance of floors, no account shall be taken of any fire resistance attributable to any suspended ceiling unless the ceiling is constructed specifically as a fire protecting suspended ceiling.

2.3.3.6 Fire rated boards are permitted to be used for protection to structural steel beams and columns in station if the following conditions are satisfactorily fulfilled:

- (a) Material shall be non-combustible (BS476 Pt 4); and
- (b) It shall have fire resistance rating at least equal to that of elements of structure required under Table 2.3.4A; and
- (c) It shall meet the criteria, in terms of water absorption and bending strength performance, when subject to test of BS1230 Pt 1 (for gypsum plaster board) or ISO 1896 (for calcium silicate or cement board); and

Suspended ceiling

Fire rated board for steel structure

- (d) The fire rated boards shall be constructed to be in contact with the steel column. If it is unavoidable, the void space between the fire rated board and the steel column shall be adequately filled to a height of 1.2 m, measured from finished floor level, with fire protective material such as concrete, gypsum or grout to prevent any possible denting of the boards; and
- (e) There shall be no services running in the space between the steel structure and fire rated boards, unless these services are encased in concrete or run in steel conduits.

2.3.4 TEST OF FIRE RESISTANCE

2.3.4.1 Performance for the fire resistance of elements of structure, doors and other forms of construction shall be determined by reference to the methods specified in BS 476: Part 20 to 23, which specify tests for stability, integrity and insulation.

Specific requirements for each element in terms of the three performance criteria of stability, integrity and insulation are given in Table 2.3.4A.

2.3.4.2 An element of structure, door or other part of a station shall be deemed to have the requisite fire resistance if:

- (a) It is constructed to the same specification as that of a specimen exposed to test by fire in accordance with the method and procedure under BS 476:Part 20 to 23, and satisfied the requirements of that test for the three performance criteria of stability, integrity and insulation for not less than the specified period , or
- (b) In the case of a wall, beam, column, stanchion or floor to which APPENDIX C relates, it is constructed in accordance with one of the specification set out in that Appendix and the notional period of fire resistance given in that Appendix as being appropriate to that type of construction and other relevant factors is not less than the specified period.
- (c) In the case of structural concrete, it is constructed to comply with SS CP65 Part 1: Design and construction and SS CP65 Part 2: Special circumstances.

Fire resistance

"Deem to satisfy" provisions

2.3.5 EXTERNAL WALL

2.3.5.1 External walls (including any external cladding or internal lining) shall:

- (a) Be constructed wholly of non-combustible materials.
- (b) Be so constructed as to attain the fire resistance required by this Standard.

2.3.5.2 Except where otherwise provided, unprotected areas in any side of a station shall comply with the following:

- (a) Any relevant requirements relating to the permitted limits of unprotected areas specified in APPENDIX D unless the station is so situated that such side may in accordance with APPENDIX D consists entirely of any unprotected area, and
- (b) The extent of unprotected openings in an external wall of a station in relation to its distance from the lot boundary may be double that which is specified in APPENDIX D when the station or compartment is fitted throughout with an automatic sprinkler system in compliance with the requirements in Section 2.5, and
- (c) For the calculations of unprotected areas, platform public areas shall be excluded from the unprotected openings calculation, and
- (d) Where a ground level entrance of an underground station is a single storey structure with no habitable room, the distance 'X' between the external wall of the entrance and the external wall of an adjacent building as shown in *Diagram 2.3.5.2(d)* shall comply with the distance stipulated in APPENDIX D based on the extent of unprotected openings in the external wall of the adjacent building.

2.3.5.3 Cladding on external walls shall be of non-combustible construction.

2.3.5.4 Any reference to APPENDIX D shall be construed as referring to the provisions of Part I of that Appendix together with (at the option of the person intending to erect the building) the provisions of Part II.

Requirements of external walls

Unprotected areas in any side of a station

Cladding on external walls

Reference to Part I-II of APPENDIX D

2.3.5.5 If two or more detached stations are erected on land in common occupation, any external wall of any station so erected which faces an external wall of such other station, the relevant boundary shall be a notional boundary passing between those stations and such boundary must be capable of being situated in such a position as to enable the external walls of those stations to comply with the requirements of Cl. 2.3.5.2.

Stations on land in common occupation

2.3.5.6 For high and low parts of different compartments of a station abutting each other, either one of the following requirements shall be complied with to prevent spread of fire from the roof close to and lower than the external of the higher part:

Vertical fire spread

- (a) The roof over the lower part of the station shall be fire rated in accordance with the element of structure for minimum 1 hour for a distance of 5 m measured horizontally from the external wall of the higher part of station; or
- (b) The external wall of the higher part of the station overlooking the roof below shall have the necessary fire resistance rating in accordance with the element of structures for minimum 1 hour for a vertical height of not less than 9 m measured from the roof of the lower part of the station.

2.3.6 **SEPARATING WALLS**

2.3.6.1 Every separating wall shall:

Requirements of separating walls

- (a) Form a complete barrier in the same continuous vertical plane through the full height between the building and station it separates, including roofs and basements, shall be imperforate except for provisions of openings permitted under Cl. 2.3.6.2, and
- (b) Have the appropriate fire resistance to comply with the requirements of Cl. 2.3.3, and
- (c) Be constructed of non-combustible materials, together with any beam and column which form part of the wall and any structure which it carries.
- (d) Not include glass fire resisting walls.

| | | |
|---------|--|---|
| 2.3.6.2 | <p>A separating wall shall have no openings except for:</p> <ul style="list-style-type: none"> (a) A door required to provide a means of escape in the event of a fire, having the same fire resistance as that required for the wall and complying with Cl. 2.3.9.2, or (b) A door provided for the purpose of public circulation, having the same fire resistance as that required for the wall and complying with Cl. 2.3.9.2, or (c) Opening for the passage of a pipe complying with the relevant provisions of Cl. 2.3.9.3. | Openings in separating walls |
| 2.3.6.3 | <p>A separating wall shall be either carried up to form a close joint with the underside of a pitched roof of non-combustible covering or carried up above the level of such roof covering. The junctions between such separating wall and roof shall be properly fire-stopped so as not to render ineffective the resistance of such separating wall to the effects of the spread of fire.</p> | Separating wall - roof junction |
| 2.3.6.4 | <p>If any external wall is carried across the end of a separating wall, such external wall and separating wall shall be bonded together or the junction of such walls shall be fire-stopped to comply with the requirements of Cl. 2.3.12.</p> | Separating wall - external wall junction |
| 2.3.6.5 | <p>No combustible material shall be built into, carried through or carried across the ends of or carried over the top of separating walls in such a way as to render ineffective such separating walls to the effects of the spread of fire.</p> | Prohibition of combustible materials in separating wall |
| 2.3.7 | <p>COMPARTMENT WALLS AND COMPARTMENT FLOORS</p> | |
| 2.3.7.1 | <p>Every compartment wall or compartment floor shall be required to:</p> <ul style="list-style-type: none"> (a) Form a complete barrier to fire between the compartments it separates, and (b) Have the appropriate fire resistance to comply with the requirements of Cl. 2.3.3, and (c) Be constructed of non-combustible materials (together with any beam or column which forms part of the wall or floor and any structure which it carries). | Requirements of compartment walls or compartment floors |

| | | |
|---------|--|---|
| 2.3.7.2 | A compartment wall or compartment floor shall have no openings in it, except for: | Openings in compartment walls or compartment floors |
| | <ul style="list-style-type: none"> (a) A door which has the same fire resistance rating as the compartment wall and complies with the relevant requirements of Cl. 2.3.4, unless permitted by other provisions of the Standard, or (b) A protected shaft which complies with the requirements of Cl. 2.3.8, or (c) The passage of a pipe or ventilation duct, | |
| | Such openings in the compartment wall or compartment floor shall be protected to comply with the relevant provisions of Cl. 2.3.9. | |
| 2.3.7.3 | Where a compartment wall or compartment floor forms a junction with any structure comprising any other compartment wall, or any external wall, separating wall or structure enclosing a protected shaft, such structures shall be bonded together at the junctions or the junctions shall be fire-stopped to comply with the requirements of Cl. 2.3.12. | Junction with other structures |
| 2.3.7.4 | Where a compartment wall forms a junction with a roof, such compartment wall shall be carried up to form a close joint with the underside of the roof and shall be properly fire-stopped or shall be carried up above the level of the roof covering and the junctions between such compartment wall and roof shall be properly fire-stopped so as not to render ineffective the resistance of such compartment wall to the effects of the spread of fire. | Compartment wall - roof junctions |
| 2.3.7.5 | No combustible material shall be built into, carried through or carried across the ends of any compartment wall or compartment floor or carried over the top of any compartment wall in such a manner as to render ineffective the resistance of such wall or floor to the effects of the spread of fire. | Prohibition of combustible materials |
| 2.3.8 | PROTECTED SHAFTS | |
| 2.3.8.1 | A protected shaft shall not be used for any purpose additional to those given as defined under Cl. 2.1.2.57. | Purpose of protected shaft |
| 2.3.8.2 | Every protected shaft shall be required to: | Requirements of protected shaft |
| | <ul style="list-style-type: none"> (a) Form a complete barrier to fire between the different compartments which the shaft connects, and | |

| | |
|--|--|
| <ul style="list-style-type: none"> (b) Have the appropriate fire resistance to comply with the requirements of Cl. 2.3.3, and (c) Be constructed of non-combustible material (together with any beam or column which forms part of the enclosure and any structure which carries it). | |
| <p>2.3.8.3 A protected shaft shall have no openings in its enclosure, except:</p> | |
| <ul style="list-style-type: none"> (a) In the case of any part of the enclosure which is formed by a separating wall, any opening which complies with the requirements of Cl. 2.3.6 for separating walls, or (b) In the case of any part of the enclosure which is formed by a compartment wall or a compartment floor, any opening which complies with the requirements of Cl. 2.3.7 for compartment wall or compartment floor, or (c) In the case of any part of the enclosure which is formed by the protecting structure: <ul style="list-style-type: none"> (i) A door which has the appropriate fire resistance to comply with the requirements of Cl. 2.3.4 for test of fire resistance, or otherwise permitted by provision of Cl. 2.3.8.6, or (ii) The passage of a pipe, or (iii) Inlets to and outlets from and opening for the duct, if the shaft contains or serves as a ventilation duct, | <p>Openings in protected shaft</p> |
| <p>Such openings in the protected shaft shall be protected to comply with the relevant provisions of Cl. 2.3.9 for protection of openings.</p> | |
| <p>2.3.8.4 Every protecting structure shall be constructed wholly of non-combustible materials.</p> | <p>Non-combustibility of protecting structures</p> |
| <p>2.3.8.5 A protected shaft used for the passage of people, such as exit staircases, shall be ventilated to comply with the relevant provisions of the Standard.</p> | <p>Ventilation of protected shaft</p> |

2.3.8.6 Any door fitted to an opening in protecting structure shall have fire resistance for not less than half the period required by other provisions of the Standard for the protecting structure surrounding the opening.

Doors in protecting structures

2.3.8.7 A protected shaft which contains an exit staircase shall comply with the following:

- (a) It shall not contain any pipe conveying gas or combustible liquid.
- (b) It shall not contain any services that are not solely serving the same exit staircase except for:
 - (i) Sprinkler pipe, dry riser pipe, hose reel pipe, fire alarm system cable in metal conduit; and
 - (ii) UPVC or cast iron rain water downpipes serving the roof directly above the exit staircase, and not routed through anywhere outside the staircase.
 - (iii) Telecommunication cables, e.g. leaky coaxial cables (LCX) and PA system cables.
- (c) The protecting structure shall be constructed of masonry or drywall. If drywall construction is used, the following conditions shall be complied with:
 - (i) Drywall shall be non-combustible; and
 - (ii) Drywall shall have the requisite fire resistance rating at least equal to that of elements of structure; and
 - (iii) Drywall shall meet the criteria, in terms of impact and deflection performance, when subject to the tests of BS 5588 Pt 5 Appendix A and BS 5234 Pt 2; and
 - (iv) Drywall shall meet the criteria, in terms of water absorption and bending strength performance, when subject to test of BS1230 Pt 1 (for gypsum plaster board) or ISO 1896 (for calcium silicate or cement board).
 - (v) There shall have at least two independent exits.

Protected shaft containing exit staircase

2.3.8.8 A protected shaft which contains a lift shall comply with the following:

Lift shaft

- (a) It shall not contain any pipe conveying gas or combustible liquid, other than those in the mechanism of a hydraulic lift.
- (b) The protecting structure shall be constructed of masonry or drywall. If drywall construction is used, the following conditions shall be complied with:
 - (i) Drywall shall be non-combustible; and
 - (ii) Drywall shall have the requisite fire resistance rating at least equal to that of elements of structure; and
 - (iii) Drywall shall meet the criteria, in terms of impact and deflection performance, when subject to the tests of BS 5588 Pt 5 Appendix A and BS 5234 Pt 2; and
 - (iv) Drywall shall meet the criteria, in terms of water absorption and bending strength performance, when subject to test of BS1230 Pt 1 (for gypsum plaster board) or ISO 1896 (for calcium silicate or cement board).
 - (v) Drywall shall meet the criteria of Cyclic Loading and Dynamic test as specified under Cl. 3.3 of Building Code of Australia Specification C 1.8.
- (c) The lift shall be considered as not enclosed within a protected shaft where a lift is:
 - (i) Located at the edge of atrium floors, or
 - (ii) At the external wall and outside the station, or
 - (iii) Located in the public area which serves not more than 3 storeys within the same compartment.

- (d) The protected shaft shall be vented in accordance with SS 550 Code of Practice for Installation, Operation and Maintenance of Electric Passenger and Goods Lifts. The vents shall be so arranged as to induce exhaust ventilation of the shaft. Where vents could not be provided because of the location of the lift shaft, ventilation duct protected by drywall complying with Cl. 2.3.8.8(b) serving as ventilation of the shaft may be provided in accordance with Section 2.6.
- (e) Openings for the passage of lift cables from the lift shaft into the lift motor room shall be as small as practicable.
- (f) Transom panel above lift entrance shall not be considered as part of the entrance and shall therefore conform to the fire resistance requirements of the protected structure.
- (g) If it serves any basement storey and not adjoining any void connecting to upper levels or any external spaces, there shall be provided a lobby enclosed by walls having fire resistance of not less than 1 hour and fire door of not less than half an hour.

Exception: The requirement for lobbies shall not apply where lift is located in the public areas which serves not more than 3 basement storeys within the same compartment.

2.3.8.9 A protected shaft used for the enclosure of services shall comply with the following:

- (a) The protecting structure for protected shaft containing mechanical ventilation ducts serving exit staircases, exit passageways, smoke-stop, and fire-fighting lobbies which pass through one or more floors shall be constructed of masonry or drywall. Such shaft shall be completely compartmented from the rest of the shaft space containing other ducts or any other services installations. Protected shaft containing ducts serving other areas which pass through two or more floors shall be constructed of drywall. If the protecting structure for the protected shaft is constructed of drywall, the following conditions shall be complied with:
 - (i) Drywall shall be non-combustible; and

Protected shaft containing other services installations

- (ii) Drywall shall have the requisite fire resistance rating at least equal to that of elements of structure; and
 - (iii) Drywall shall meet the criteria, in terms of impact and deflection performance, when subject to the tests of BS 5588 Pt 5 Appendix A and BS 5234 Pt 2; and
 - (iv) Drywall shall meet the criteria, in terms of water absorption and bending strength performance, when subject to test of BS1230 Pt 1 (for gypsum plaster board) or ISO 1896 (for calcium silicate or cement board).
- (b) Where protected shafts are interrupted by barriers with fire resistance of at least half an hour at every floor level, fire resisting doors opening into the protected shaft are not required to be installed with automatic self-closing devices, provided such doors are kept closed and locked at all times.
 - (c) Fire resistant cables, flame retardant cables and extra low voltage telecommunication cables need not be housed in protected shafts.

Omission of self-closing devices

2.3.9 PROTECTION OF OPENINGS

2.3.9.1 The provisions of this Clause are made in connection with the protection of openings permitted in elements of structure or other forms of fire resisting construction required to act as a barrier to fire and smoke.

Application

2.3.9.2 Fire doors for protection of openings shall comply with the following:

Fire doors

- (a) Fire doors shall be constructed of non-combustible materials having the appropriate fire resistance as required by relevant parts of the Standard, and two fire doors may be fitted in an opening if each door by itself is capable of closing the opening and the two doors together achieve the required level of fire resistance, and
- (b) Except as permitted in Cl. 2.3.8.9(b) and Cl. 2.3.9.2(h), all fire doors shall be fitted with an automatic self-closing device which is capable of closing the door from any angle and against any latch fitted to the door, and

- (c) Fire doors or shutters held open by electromagnetic or electro-mechanical devices shall be activated to close by the localized smoke detector(s) on either (one) side of the fire doors or shutters, and

Exemption: Fire shutters in non-public areas (i.e. activated by fusible link only).
- (d) Use of fire shutter not exceeding 6m in width shall be permitted.
- (e) Any fire door fitted in an opening which is provided as a means of escape:
 - (i) Shall be capable of being opened manually, and
 - (ii) Shall not be held open by any means other than by an electromagnetic or electro-mechanical device which can be activated by the presence of smoke and/or the fire alarm system, provided that this shall not apply in the case of fire doors opening into pressurised exit staircases, and
 - (iii) Shall open in the direction of exit travel in accordance with Cl. 2.2.5.13(d).
- (f) Fire resisting doors where required to be provided shall be constructed and installed to comply with specifications stipulated under SS 332 Specification for Fire Doors and SS 489 Specification for Fire Shutters.
- (g) Fire shutters shall not be used as security shutters.
- (h) The inactive leaf of double-leaf doors for plant/equipment/machine rooms and for lobby/corridor leading to these rooms, where the inactive leaf is only for use as equipment access, need not be fitted with a self-closing device, but must be bolted in place and fitted with a sign “Keep door bolted”.

2.3.9.3 Pipes

- (a) Pipes which pass through a separating wall, compartment wall or compartment floor shall be kept as small as possible and fire-stopped around the pipe. The nominal internal diameter of the pipe shall be not more than the relevant dimension given in Table 2.3.9A with the exception of pipes having the necessary fire resistance when tested to BS 476: Part 20 or other acceptable standards. Clear spacing between pipes shall be minimum 50mm or ½-diameter of the largest pipe, whichever is the larger.

Exception: Emergency standby diesel generator steel exhaust pipes connected directly to the external.

- (b) In additional to sub-clause (a), fuel and vent pipes for emergency standby diesel generators and fuel tanks located outside the room they served shall be enclosed in construction having fire resistance of not less than 2 hours. They shall not be located in intake/fresh air vent shaft.

2.3.9.4 Ventilation duct which passes directly through a compartment wall or compartment floor shall comply with the following -

- (a) Where the ventilation duct does not form a protected shaft or is not contained within a protecting structure,
 - (i) The duct shall be fitted with a fire damper where it passes through the compartment wall or compartment floor, and
 - (ii) The opening for the duct shall be kept as small as practicable and any gap around the fire damper shall be fire-stopped.
- (b) Where the ventilation duct forms a protected shaft or is contained within a protecting structure, the duct shall be:
 - (i) Fitted with fire dampers at the inlets to the shaft and outlets from it, and
 - (ii) Constructed and lined with materials in accordance with the requirements in Section 2.6.
- (c) The installation of ventilation ducts and fire dampers shall comply with the requirements in Section 2.6.

Pipes

Ventilation ducts

| | | |
|----------|---|-------------------------------------|
| 2.3.9.5 | Duct encasing one or more flue pipes which passes through a compartment wall or compartment floor shall be of non-combustible construction having fire resistance of not less than half the minimum period of fire resistance required for the compartment wall or compartment floor through which it passes. | Flues |
| 2.3.9.6 | Air ducts and other services that are likely to permit the passage of flame or smoke in the event of a fire shall not be permitted to pass through rooms housing fire pump, emergency generator or fans handling smoke control system except where such services are required for the operation of these equipment. | Service pipings and ductings |
| 2.3.9.7 | Where a CD blast door or CD air-tight door is installed in a fire-rated compartment wall and is to be use only during CD operational mode, it shall be kept in the closed position at all time and is deemed to be part of the fire-rated compartment. Signage shall be provided on both sides of the CD door that reads: “KEEP DOOR CLOSED DURING PEACE TIME”. | |
| 2.3.9.8 | Where a CD blast door or CD air-tight door is installed in a fire-rated compartment wall and is required to be kept in the fully opened position in accordance with Section 2.2, a fire-rated door shall be provided in the doorway in accordance with the Fire Code to maintain the integrity of the fire-rated compartment. | |
| 2.3.9.9 | Where CD blast valves are installed in a fire-rated compartment wall, fire shutters or demountable fire-rated panels shall be provided across the CD blast valves to maintain the integrity of the fire-rated compartment walls during peace time. | |
| 2.3.10 | EXIT STAIRCASES | |
| 2.3.10.1 | Every exit staircase, including the treads/risers and landing, shall be constructed of non-combustible materials. | Non-combustibility of structure |
| 2.3.10.2 | The exit staircase shall be separated from other parts of the station by a masonry structure or drywall complying with Cl. 2.3.8.7(c) which shall have fire resistance for not less than the period required by Cl. 2.3.3 for Elements of Structure. | Structure separating exit staircase |

| | | |
|----------|--|---|
| 2.3.10.3 | Doors opening into the exit staircase shall have fire resistance of at least half an hour and fitted with automatic self-closing device. | Exit doors |
| 2.3.10.4 | Finishes to the ceilings/walls and floors of exit staircase shall be of non-combustible materials. | Finishes |
| 2.3.11 | CONCEALED SPACES | |
| 2.3.11.1 | Concealed spaces in a station shall be interrupted by construction of cavity barriers to restrict the spread of smoke and flames. | General provision |
| 2.3.11.2 | Cavity barriers shall be used to close the edges of cavities, edges around openings through a wall, floor and any other part of the construction which contains a cavity and to separate any cavity in a wall, floor or any other part of the construction from any other such cavity. | Closing the edges of cavities |
| 2.3.11.3 | Cavities shall be interrupted by cavity barriers where a wall, floor, ceiling, roof or other part of the construction abut the cavity, if there is provision for the element of structure to form a fire resisting barrier. Such cavity barriers shall be of fire resisting construction at least equal to the provision for that required for the fire resisting barrier. | Interrupting cavities |
| 2.3.11.4 | Cavities, unless otherwise permitted, shall be sub-divided so that the maximum distance between cavity barriers in any direction shall not exceed 20 m. | Sub-division of extensive cavities |
| 2.3.11.5 | Cavity barriers shall be: (a) Constructed to provide at least half an hour fire resistance, and (b) Tightly fitted to rigid construction or the junctions shall be fire stopped to comply with the requirements of Cl. 2.3.12. | Fire resistance and fixing of cavity barriers |
| 2.3.11.6 | A cavity barrier shall have no opening in it except for: (a) A door which has at least half an hour fire resistance and shall be kept closed all the time, (b) A pipe which complies with the provision under Cl. 2.3.9.3, (c) A cable or conduit containing one or more cables, | Openings in cavity barriers |

- (d) An opening fitted with suitably mounted automatic fire damper, and
- (e) A duct which is fitted with a suitably mounted automatic fire damper where it passes through the cavity barrier.

2.3.11.7 The construction of raised floors with or without accessible panels shall comply with the following requirements :

- (a) The supporting structure shall be constructed of non-combustible materials having a melting point of at least 800°C, and
- (b) The concealed space between the structural floor and raised floor shall not be used for storage purpose, and
- (c) No services or installation shall be permitted within the concealed space other than
 - (i) Electrical wiring in metal conduit and metal trunking in compliance with the requirements of SS CP 5 Code of Practice for Wiring of Electrical Equipment of Buildings;
 - (ii) Communication cables for computer equipment;
 - (iii) Fire protection installations serving the area, and
- (d) Where the raised floor is used as a plenum, requirements in Section 2.6 shall be satisfied, and
- (e) Decking of the raised floor shall be constructed of non-combustible material or where combustible material is used as core material, if allowed in the case of sprinkler protected areas/compartment, the top, bottom, all sides and cut edges shall be covered with material with surface property complying with Class 0 (excluding materials for floor finishes), and
- (f) In the case of raised floors with accessible panels, access sections or panels shall be provided such that all concealed spaces between the structural floor and raised floor are easily accessible, and
- (g) Openings in the raised floor for entry of electrical cables shall be effectively closed to prevent entry of debris or other combustible material into the concealed spaces, and

Raised floors with or without accessible panels

- (h) All sides shall be properly sealed, and
- (i) The concealed space shall be sub-divided by cavity barriers such that the maximum unobstructed area within the concealed space do not exceed 930m², and
- (j) Where the concealed space is fitted with an automatic sprinkler system which complies with the requirements in Section 2.5, cavity barriers are not required, and
- (k) The height of concealed space measured between the top of the structural floor and underside of the raised floor decking shall not exceed 400 mm and shall be fitted with automatic detection system complying with requirements of SS CP 10 Code of Practice for the Installation and Servicing of Electrical Fire Alarm Systems; and in the case of sprinkler protected compartment, the height of concealed space may exceed 400 mm if the space is fitted throughout with an automatic sprinkler system which complies with the requirements in Section 2.5.

2.3.11.8 The concealed spaces of suspended ceiling over an exit passageway, smoke-stop lobby, exit staircase or other designated means of escape facilities, shall comply with the following:

- (a) The ceiling supporting elements and the ceiling shall be constructed of non-combustible materials; and
- (b) The exposed surfaces within the concealed space shall be of Class 0 surface flame spread.

2.3.11.9 Provision of cavity barriers within the concealed spaces of suspended ceiling is exempted if the following requirements are complied with:

- (a) The concealed space are not used for storage purpose, and
- (b) The supporting elements shall be constructed of non-combustible material, and
- (c) The exposed surfaces within the concealed space is of Class 0 flame spread, (excluding surfaces of any pipe, cable, conduit or insulation of any pipe), and

Suspended ceiling over protected areas

- (d) If the concealed space does not exceed 800 mm in depth or if the concealed space is fitted with:
 - (i) detectors which comply with the SS CP10, or
 - (ii) an automatic sprinkler system comply with SS CP 52.

2.3.12 FIRE STOPPING

2.3.12.1 Openings for pipes, ducts, conduits or cables which pass through any part of an element of structure (except for a part which does not serve as a fire resisting barrier) or cavity barrier, shall be:

General provision

- (a) Kept as few in number as possible, and
- (b) Kept as small as practicable, and
- (c) All gaps shall be filled with fire-stopping materials.

2.3.12.2 Fire-stopping shall be of material having the necessary fire resistance when tested to BS 476: Part 20 or other acceptable standards.

Fire-stopping

2.3.12.3 Suitable fire-stopping materials include:

Materials for fire-stopping

- (a) Proprietary fire-stopping and sealing systems (including those designed for service penetrations) which have been shown by test to maintain the fire resistance of the wall or other element, and are listed under the Singapore Productivity & Standards Board's Product Listing Scheme.
- (b) Other fire-stopping materials include:
 - (i) Cement mortar;
 - (ii) Gypsum based plaster;
 - (iii) Cement or gypsum based vermiculite / perlite mixes;
 - (iv) Glass fibre, crushed rock, blast furnace slag or ceramic based products (with or without resin binders); and

(v) Intumescent mastics.

The method of fire-stopping and choice of materials should be appropriate to the situation and its application.

2.3.13 **RESTRICTION OF SPREAD OF FLAME OVER SURFACES OF WALLS AND CEILINGS**

2.3.13.1 Any reference to a surface being Class 0 shall be construed as a requirement that:

- (a) The material of which the wall or ceiling is constructed shall be non-combustible throughout; or
- (b) The surface material (or, if it is bonded throughout to a substrate, the surface material in conjunction with the substrate) shall have a surface of Class 1 and if tested in accordance with BS 476:Part 6 shall have an index of performance (I) not exceeding 12 and a sub-index (i) not exceeding 6.

2.3.13.2 Any reference to a surface being of a class other than Class 0 shall be construed as a requirement that the material which the wall or ceiling is constructed shall comply with the relevant test criteria as to surface spread of flame specified in relation to that class in BS 476:Part 7.

2.3.13.3 Class 0 shall be regarded as the highest class followed by Class 1 as set hereunder:

- Class 0 - Surface of no Flame Spread. Those surfaces that conform to the requirements of Cl. 2.3.13.1.
- Class 1 - Surface of Very Low Flame Spread. Those surfaces on which not more than 150mm mean spread of flames occurs under the relevant test conditions.

2.3.14 **ROOFS**

2.3.14.1 Materials for roof covering and roof construction shall be non-combustible.

2.3.14.2 At the junctions with separating wall or compartment wall, roof construction shall comply with the relevant requirements under Cl. 2.3.6.3 and Cl. 2.3.7.4 respectively

Requirements for Class 0

Requirements for a class other than class 0 classification

Classification

Roof construction

Roof junction with separating wall and compartment wall

2.3.15 MATERIALS FOR CONSTRUCTION

- 2.3.15.1 (a) Materials used in the construction of building elements shall comply with the provisions stated under this section in addition to the performance requirements such as for fire resistance stipulated in other relevant sections.
- (b) Intumescent paint is allowed to be used for protection of structure steel members to achieve the required fire resistance, provided:
- (i) The paint shall be of a proprietary system that has been demonstrated to achieve the fire resistance performance as required in BS 476 Part 20 / 21 or its equivalent, together with the specified weathering tests as specified in the BS 8202: Part 2- 1992;
 - (ii) They shall be used to protect structural beams only, excluding load transfer beams, if the habitable height of the station exceeds 24m;
 - (iii) Coating of intumescent paint onto structural steel, and subsequent maintenance shall conform to BS 8202: Part 2: 1992; and
 - (iv) All requirements stipulated in Appendix H - “Notes on the use of Intumescent Paints for Protection to Structural Steel Members of Stations” shall be complied with.
- (c) Flame retardant chemicals, intended for upgrading of fire resistance rating of any combustible material, shall not be allowed to improve the required fire resistance.
- 2.3.15.2 All elements of structure shall be constructed of non-combustible materials in addition to the relevant provisions as follows:
- (a) Cl.2.3.3 for fire resistance of Elements of Structure,
 - (b) Cl.2.3.5.1 & 2.3.5.3 for External Walls,
 - (c) Cl.2.3.6.1(c)/(d) & 2.3.6.5 for Separating Walls,
 - (d) Cl.2.3.7.1(c) & 2.3.7.5 for Compartment Walls and Compartment Floors,

Material for construction

- (e) Cl.2.3.8.2(c), 2.3.8.4, 2.3.8.7(c), 2.3.8.8(b), 2.3.8.8(f) & 2.3.8.9(a) for Protected Shafts.
- 2.3.15.3 Materials used for the protection of openings shall comply with the relevant provisions of Cl. 2.3.9 of the Standard for protection of openings.
- 2.3.15.4 Exit staircases shall be constructed of non-combustible materials to comply with the provisions of Cl. 2.3.10.1.
- 2.3.15.5 Materials used for the construction of raised floors shall comply with the provisions of Cl. 2.3.11.7(a) and Cl. 2.3.11.7(e).
- 2.3.15.6 Materials used for construction of ceiling supports shall comply with the provisions of Cl. 2.3.11.8(a).
- 2.3.15.7 Materials used for fire stopping shall comply with the relevant provisions of Cl. 2.3.12.2 and 2.3.12.3.
- 2.3.15.8 Materials used for roof construction shall comply with the provisions of Cl. 2.3.14.1.
- 2.3.15.9 Internal non-load bearing walls, partitions, claddings/wall panels, false ceiling, balustrades and railings in stations, including the materials for surface finishes, shall be constructed of non-combustible materials.
- Exception: Wall finishes in the form of thin sheets of not more than 1.0 mm thickness mounted on non-combustible substrate in commercial space where sprinkler protection is provided.
- 2.3.15.10 Composite panels and sandwich panels which has non-combustible covering but consist of plastic or combustible core are prohibited.
- 2.3.15.11 PVC pipes are prohibited in underground stations.
- Exception 1: Encased PVC pipes in concrete.
- Exception 2: PVC pipe sleeves in structure.
- Exception 3: Condensate drain pipes for air-conditioning units.

2.3.15.12 Fire-rated glass if used as walls and doors for fire compartmentation of shops, shall comply with the following:

- (a) The necessary fire resistance, including insulation, when subject to test under BS 476: Part 20-23; and
- (b) Class A of the Impact Performance requirements when subject to test under BS 6206 or AS 2208.

Fire-rated
Glass

Table 2.3.2A SIZE LIMITATION OF STATION AND COMPARTMENT

| (1) Compartments | (2) Maximum Floor Area | (3) Maximum Cubical Extent |
|---|------------------------------|----------------------------------|
| Compartment below ground level. No compartment to comprise more than one storey (*). | 2000 m ² | 7500 m ³ |
| Compartments between average ground level and a height of 24 m. No compartment to comprise more than 3 storeys. | 4000 m ² | 15000 m ³ |
| Compartments above a height of 24 m from average ground level. No compartment to comprise more than one storey. | 2000 m ² | 7500 m ³ |

(*) Size limitation of compartment below ground level is not applicable to the public area. Public area below ground level shall comply with Cl. 2.3.2.4(e).

Table 2.3.4A
SPECIFIC PROVISIONS OF TEST FOR FIRE RESISTANCE
OF ELEMENTS OF STRUCTURE ETC

| Part of station | Minimum provisions when tested to BS 476: Part 20-23 (minutes) | | | Method of exposure |
|---|---|----------------|----------------|---|
| | Stability | Integrity | Insulation | |
| 1 Structural frame, beam or column | * | no requirement | no requirement | exposed faces |
| 2 Loadbearing wall which is not also an external wall, Separating wall, Compartment wall or Protecting structure (See 4, 5, 6 or 7) | * | no requirement | no requirement | each side separately |
| 3 Floors | * | * | * | from underside |
| 4 External walls | | | | |
| (a) any part less than 1 m from point of relevant boundary | * | * | * | each side separately |
| (b) any part 1 m or more from the relevant boundary | * | * | 15 | from inside |
| 5 Separating wall | * | * | * | each side separately |
| 6 Compartment wall | * | * | * | each side separately |
| 7 Protecting structure any part | * | * | * | each side separately |
| 8 Doors | | | | |
| (a) in a separating wall | no provision | + | no provision | each side separately when fitted in its frame |
| (b) in a compartment wall | no provision | + | no provision | each side separately when fitted in its frame |
| (c) in a protecting structure | no provision | ** | no provision | each side separately when fitted in its frame |
| (d) any other door (including a door in a cavity barrier) | no provision | 30 | no provision | each side separately when fitted in its frame |
| 9 Cavity barrier | | | | |
| (a) cavity barrier 1m x 1m or larger | 30 | 30 | 15 | each side separately |
| (b) any other cavity barrier | 30 | 30 | no provision | each side separately |
| (c) ceiling | 30 | 30 | 30 | From underside |

Notes

- * Period of fire resistance as specified.
- + Period of fire resistance for the wall or floor in which the door is situated.
- ** Half the period of fire resistance for the wall or floor in which the door is situated.

Table 2.3.9A MAXIMUM NOMINAL INTERNAL DIAMETER OF PIPES

| Situation | Pipe material and maximum nominal internal diameter [mm] | | |
|---|--|--|--------------------|
| | Non-combustible material ¹ | Lead, aluminium or aluminium alloy, or uPVC ² | Any other material |
| Structure enclosing a Protected Shaft which is not a stairway or lift shaft | 150 | 100 | 40 |
| Any other situation | 150 | 100 (stack pipe) ³ 75 (branch pipe) ³ | 40 |

Notes

- (1) A non-combustible material (such as cast iron or steel) which if exposed to a temperature of 800 degrees Celsius will not soften nor fracture to the extent that flame or gases will pass through the wall of the pipe.
- (2) uPVC pipes complying with BS 4514:1983. Use of PVC pipes shall comply with Cl. 2.3.15.11.
- (3)
 - (i) Within toilets, wash rooms or external corridors, maximum diameter of uPVC pipes may be increased to double the size given in the above table.
 - (ii) Within areas of fire risk and adjacent to escape routes, uPVC pipes shall be enclosed by construction having fire resistance of at least one half hour.
 - (iii) Where the size of uPVC pipes exceeds that specified under this Clause, approved fire collar shall be fitted at all positions where such pipes pass through constructions required to act as a barrier to fire.

Diagram 2.3.2.4(c) - Compartmentation of additional commercial space make up of a group of shops permitted under Cl. 2.1.3

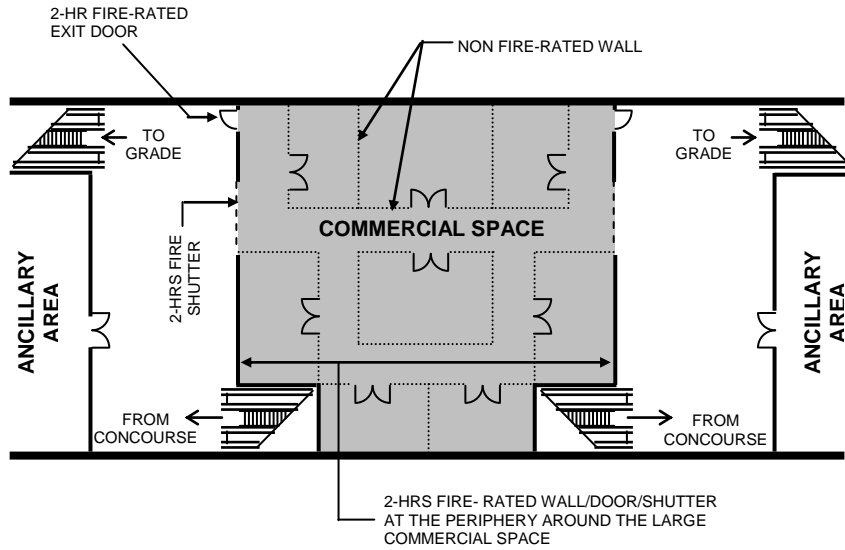

COMMERCIAL FLOOR OF STATION

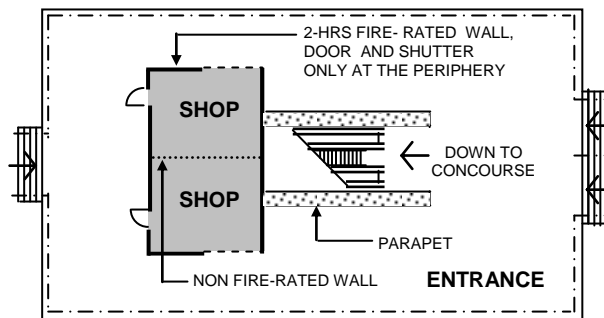

COMMERCIAL SPACES AT THE GROUND LEVEL OF STATION ENTRANCE

Diagram 2.3.3.1(c) - Fire resistance of elements of structure around the trainway in an aboveground station where there are habitable floors directly above the trainway

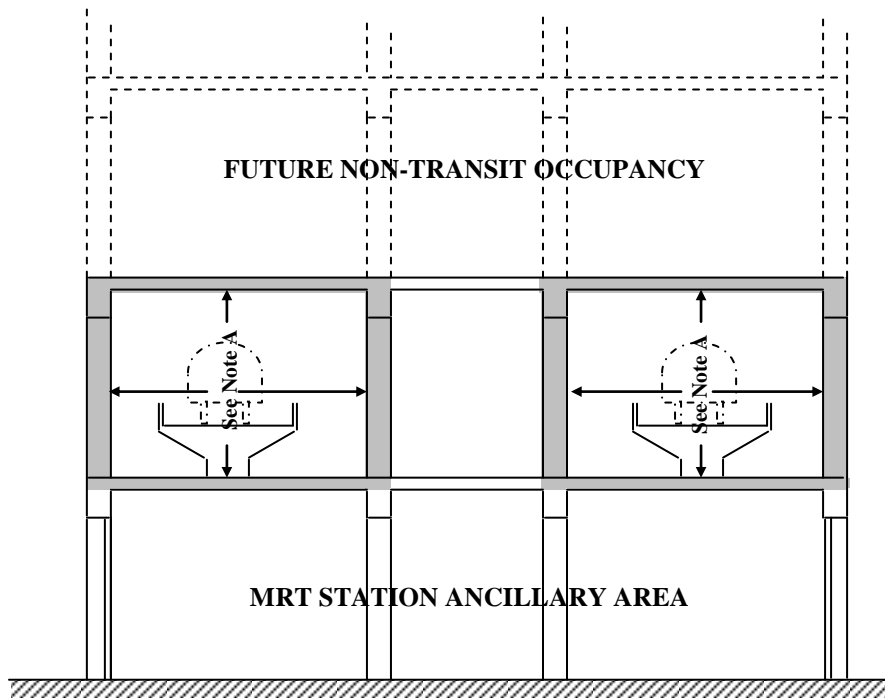

Note A : All elements of structure shall not be less than 4 hours fire rating.

Diagram 2.3.5.2(d) - Separation distance 'X' between the external wall of a ground level entrance (with no habitable room) and the external wall of an adjacent building

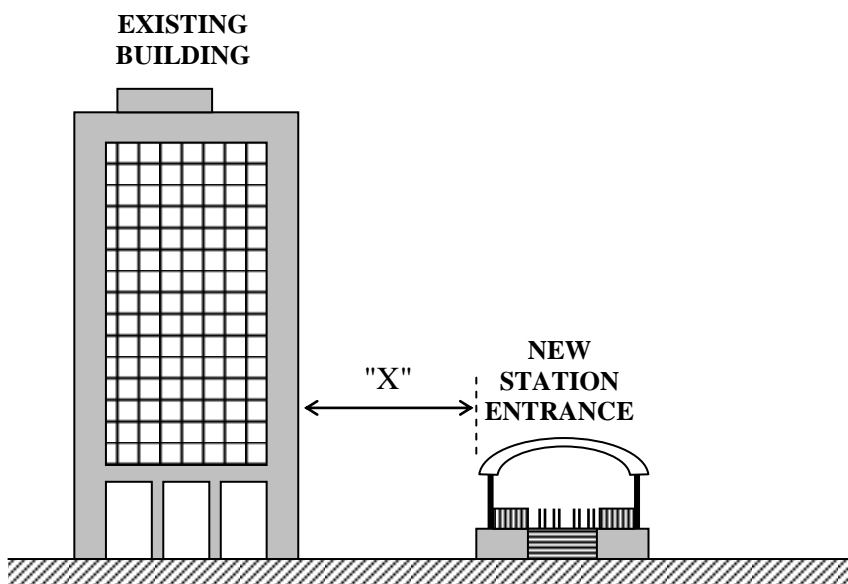

SECTION 2.4 SITE PLANNING & EXTERNAL FIRE FIGHTING PROVISIONS FOR STATIONS

ROOT OBJECTIVES

The primary intentions of this section are encapsulated in the following statements:-

- R2.4.1 Provide space at the station site to enable effective mounting of fire-fighting and rescue operations.
- R2.4.2 Fire-fighters must be provided with adequate means of access for fire-fighting and rescue operations within the station.
- R2.4.3 Provide reliable and adequate water supply to enable effective fire-fighting operations.

SUB-OBJECTIVES

The following criteria define the conditions necessary to fulfil the intentions of this section:-

- S2.4.1 Provisions for adequate and appropriate access with proper identification for effective manoeuvring of fire-fighting appliances at the station site for fire-fighting purposes.
- S2.4.2 Provisions for adequate structural capacity of accessways with proper identification to support the operational loads of the fire-fighting appliances.
- S2.4.3 Provisions for adequate and appropriate external entry locations with proper identification on the station facade for fire-fighting and rescue operations.
- S2.4.4 Provisions for adequate and appropriate access with proper identification into underground station for fire-fighting and rescue operations.
- S2.4.5 Provisions for appropriate siting of reliable and adequate hydrant water supplies and related facilities at the station site.

**SECTION 2.4
SITE PLANNING & EXTERNAL
FIRE FIGHTING PROVISION FOR STATIONS**

2.4.1 GENERAL

General

2.4.1.1 The purpose of this Section of the Standard is to make provision for space around stations to enable effective mounting of rescue and external fire fighting operations.

2.4.2 PROVISION FOR EXTERNAL ACCESS TO STATION FOR FIRE FIGHTING AND ACCESSIBILITY OF SITE TO FIRE FIGHTING APPLIANCES

2.4.2.1 Access openings along external walls of stations, firemen's staircase for underground stations, fire engine accessway and fire engine access road shall be provided for fire fighting and rescue operations.

Introduction

Exception: Access opening and fire engine accessway are not required for single storey structure of stations above ground level.

2.4.2.2 ACCESS OPENING

(a) Openings on the external wall for external fire fighting and rescue operation. Access openings shall include unobstructed external wall openings, windows, glazed wall panels or access panels. Windows, doors, wall panels or access panels must be readily openable from the inside and outside, unless fitted by breakable glazing. Inside and outside of access openings shall be unobstructed at all times during the occupancy of the station.

Access openings for above-ground stations

(b) Where an external wall which faces the accessway has external openings on each storey level that meet the requirements of sub-clauses below, there is no need to designate any access opening.

(c) Panels to access openings shall be posted with either a red or orange triangle of equal sides (minimum 150mm on each side), which can be upright or inverted, on the external side of the wall and with wordings "Fire Fighting Access - Do Not Obstruct" of at least 25mm height on the internal side.

Signage

| | |
|--|--|
| <p>(d) Access openings shall be not less than 850 mm wide by 1000 mm high with sill height of not more than 1100 mm and head height not less than 1800 mm above the inside floor level.</p> | Size |
| <p>(e) Number and position of access openings:</p> <p>i) Access openings shall be spaced at not more than 20m apart measured along the external wall from centre to centre of the access openings.</p> <p>ii) For stations with an area or space that has a ceiling height greater than 10m, high level access openings for smoke venting and fire fighting purposes shall be provided and located in the external walls opening into the area or space.</p> | Position Additional openings |
| <p>2.4.2.3 FIREMEN'S STAIRCASE</p> | |
| <p>(a) At least one firemen's staircase shall be provided for every underground station.</p> <p>(b) The entrance to firemen's staircase on the ground level shall be visible and within 18m from a fire engine access road.</p> <p>(c) Firemen's staircase shall have access to every basement storey via fire-fighting lobbies.</p> <p>(d) Fire-fighting lobby shall not be used for any other purposes and the size of the fire-fighting lobby shall not be smaller than 6m² and with no dimension smaller than 2m. Where the fire-fighting lobby has a fire lift provided under Cl.2.5.7.4(c), the floor shall be graded from the lift door towards the lobby door with a fall not exceeding 1 in 200.</p> | Firemen's staircase for underground stations |
| <p>2.4.2.4 ACCESSWAY FOR FIRE FIGHTING APPLIANCES</p> | |
| <p>(a) i) Accessway shall be provided for accessibility of site to fire fighting appliances. To permit fire-fighting appliances to be deployed, the accessway shall have a minimum width of 6m throughout its entire length. Access openings shall be provided along the external walls of station fronting the accessway to provide access into the station for fire fighting and rescue operations.</p> | Introduction |

- ii) For stations not exceeding the habitable height of 10m, accessway will not be required. However, provision of fire engine access road having minimum 4m width for pump appliances will be required to within a travel distance of 45m of every point on the projected plan area of the station.
- iii) For stations exceeding the habitable height of 10m, accessway shall be located directly below the access openings to provide direct outreach to the access openings. Accessway shall be provided based on the gross floor area (including toilets, stores, circulation spaces, etc.) of the largest floor as follows:

| | |
|--|-----------------------------|
| Minimum | 1/6 perimeter (min. 15m) |
| 2000m ² to 4000m ² | 1/4 perimeter |
| >4000m ² to 8000m ² | 1/2 perimeter |
| >8000m ² to 16000m ² | 3/4 perimeter |
| >16000m ² | island site access |

- (b) i) The accessway shall have a minimum width of 6m throughout. Such accessway must be able to accommodate the entry and manoeuvring of fire engines, extended ladders, pumping appliances, turntable and/or hydraulic platforms.
- ii) Accessway shall be positioned so that the nearer edge shall be not less than 2m or more than 10 m from the centre position of the access opening, measured horizontally.
- iii) Accessway shall be metalled or paved or laid with strengthened perforated slabs to withstand the loading capacity of stationary 30 tonnes fire engine. [See APPENDIX E for additional information]
- iv) Accessway shall be laid on a level platform or if on an incline, the gradient shall not exceed 1:15.
- v) Dead-end accessway and fire engine access road shall not exceed 46m in length or if exceeding 46m, be provided with turning facilities as shown in *Diagram 2.4.2.4(b)(v)*

Width of accessway

Location

Accessway

Gradients of accessway

Turning facilities

- vi) The outer radius for turning of access and fire engine access road shall comply with the requirements as shown in *Diagram 2.4.2.4(b)(vi)*.
 - vii) Overhead clearance of accessway and fire engine access road shall be at least 4.5m for passage of fire fighting appliances. Overhead clearance
 - viii) Public roads can serve as accessway provided the location of such public roads is in compliance with the requirements of distance from access openings. Public road
 - ix) Accessway and fire engine access road shall be kept clear of obstructions and other parts of the station, plants, trees or other fixtures shall not obstruct the path between the accessway and access openings. Obstruction
- (c)
- i) All corners of accessway shall be marked. Marking of fire engine accessway
 - ii) Marking of corners shall be in contrasting colour to the ground surfaces or finishes.
 - iii) Accessway provided on turfed area must be marked with contrasting object (preferably reflective) that is visible at night.
- The markings are to be at intervals not more than 3m apart and shall be provided on both sides of the accessway.
- iv) Sign post displaying the wordings 'Fire Engine Access - Keep Clear' shall be provided at the entrance of the accessway. Size of wordings shall not be less than 50mm.

2.4.3 ACCESS TO STATIONS WITH BREECHING INLETS

Station fitted with rising mains and automatic sprinkler system shall have fire engine access roads for pumping appliances within 18m of the breeching inlets. The breeching inlets shall be visible from the fire engine access roads. Access to stations with breeching inlets

2.4.4 PRIVATE FIRE HYDRANT

2.4.4.1 REQUIREMENTS

(a) (i) Every part of a fire engine access road and/or an accessway shall be within an unobstructed distance of 50m from a hydrant. Where a public hydrant conforming to such requirement is not available, private hydrant(s) shall be provided [see *Diagram 2.4.4.1(a)*].

(ii) Existing public hydrants along one side of a public road shall not be designated to serve developments that are sited across the other side of the public road, except for a one-way single lane or two lanes road.

(b) In situations where more than one private hydrant are required, the hydrants shall be located along the fire engine accessway such that every part of the fire engine accessway is within an unobstructed distance of 50m from any hydrant [see *Diagram 2.4.4.1(b)*].

(c) Siting and types of fire hydrants shall comply with the requirements stated in SS 574: Code of Practice for Fire Hydrant Systems and Hose Reels.

2.4.4.2 WATER SUPPLY FOR PRIVATE HYDRANT

Provision of water supply for private hydrant system where required by this Standard shall comply with one of the following requirements:

(a) Private fire hydrant installed at reduced level 125m and below can received direct supply from public water mains provided:

i) The nominal bore of the hydrant pipe and the bulk water meter shall not be less than 150mm in diameter; and

ii) The running pressure / flow at the hydraulically most unfavourable hydrant of the private hydrant system shall comply with the following:

- Running pressure $\geq 0.9 \times$ (running pressure of the nearest public hydrant - pressure drop across the bulk water metre); and

Private fire hydrant

Water supply for private hydrant

- Flow Rate $\geq 0.9 \times$ water flow of the nearest public hydrant or \geq total flow demand (as required in Table 2.4.4.2) of the private hydrant system, provided the running pressure at the remotest private hydrant is greater than 2 bars.

Note:

- (i) In calculating the frictional loss of the private hydrant system, the design flow rates shown in Table 2.4.4.2 shall be used.
 - (ii) Pressure drop across bulk water metre shall not be more than 1 bar.
- (b)
- (i) Where there is only one private hydrant in the plot that is located above reduced level 125m; and
 - (ii) this hydrant is not the sole hydrant within 50m from any breeching inlet(s) feeding into fixed water based fire fighting system(s) including automatic sprinkler systems and dry riser systems for the station standing on this plot of land;

then this hydrant may be in the form of a "dry" hydrant. A "dry" hydrant shall be connected to a 150mm diameter dry pipe, which shall be connected at the other end to a four-way breeching inlet. This breeching inlet shall be within 18m from any fire engine accessible way and within 50m from any wet hydrant, private or public.

- (c) Where there are more than one private hydrant that are located above reduced level 125m within the same plot, storage and pumping arrangements of water supply to these specified hydrants shall comply with those for wet rising mains stipulated in SS 574 and Table 2.4.4.2 - Water Supply & Storage Requirement For Private Hydrant. The water supply for hydrants shall be as follows:

Table 2.4.4.2 - Water Supply & Storage Requirement For Private Hydrant

| | |
|---|---|
| Minimum running pressure | 2 bars |
| Minimum flow rate based on the largest compartment floor area | $< 1000\text{m}^2 - 38\text{L/s}$ $< 5000\text{m}^2 - 57\text{L/s}$ $< 10000\text{m}^2 - 76\text{L/s}$ (57L/s if sprinkler protected) Additional 19L/s for subsequence 5000m ² |
| Minimum duration | 45mins |

- 2.4.4.3 All hydrant mains which pass through a station shall have its full length within the station protected with fire resistance construction of at least the same fire resistance as the element of structure, provided the following requirements are complied with:

- (a) The hydrant mains shall be located in common circulation spaces and driveways; i.e. they shall not pass through private or confined spaces;
- (b) No services (except sprinkler pipes) shall be located above or crossing over the hydrant mains;
- (c) The hydrant mains shall be located away from explosion risk areas; and
- (d) The protective enclosure to the hydrant mains shall be labelled with the words "HYDRANT MAIN" of minimum 50mm height at suitable intervals.

Protection of hydrant mains in stations

Diagram 2.4.2.4(b)(v) - Turning Facilities

Turning Facilities for Pumper Appliances (24 tonnes)
(Not to scale)

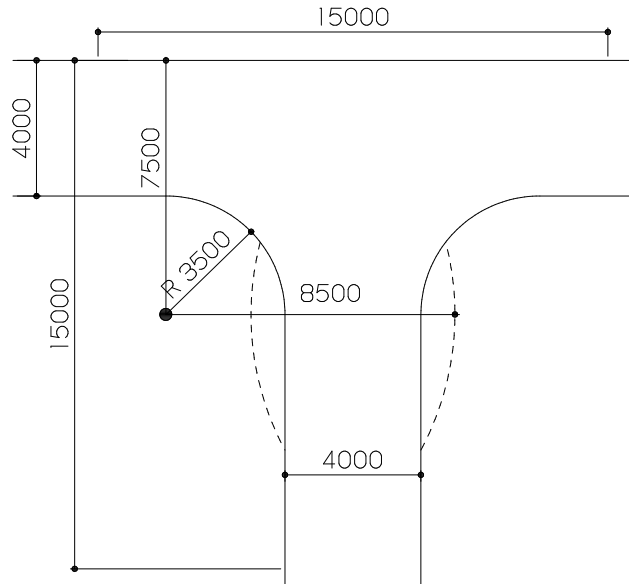

Turning Facilities for Aerial Appliances (30 tonnes)
Applicable to stations exceeding the habitable height of 10 m
(Not to scale)

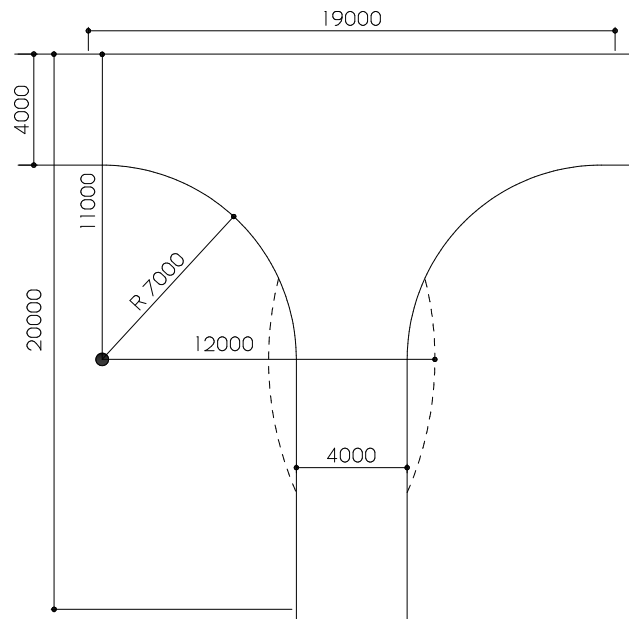
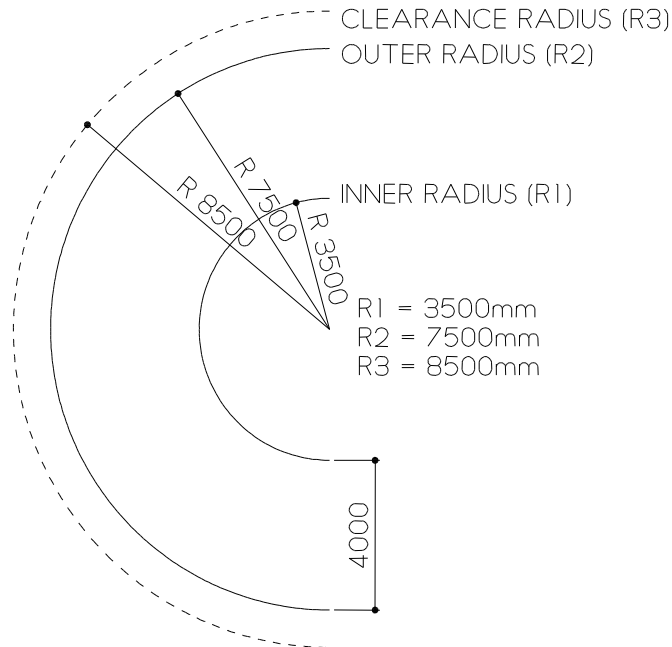

Diagram 2.4.2.4(b)(vi)

U-Turn Radii of Pumper Appliances (24 tonnes)

(Not to scale)



U-Turn Radii of Aerial Appliances (30 tonnes)

Applicable to stations exceeding the habitable height of 10m

(Not to scale)

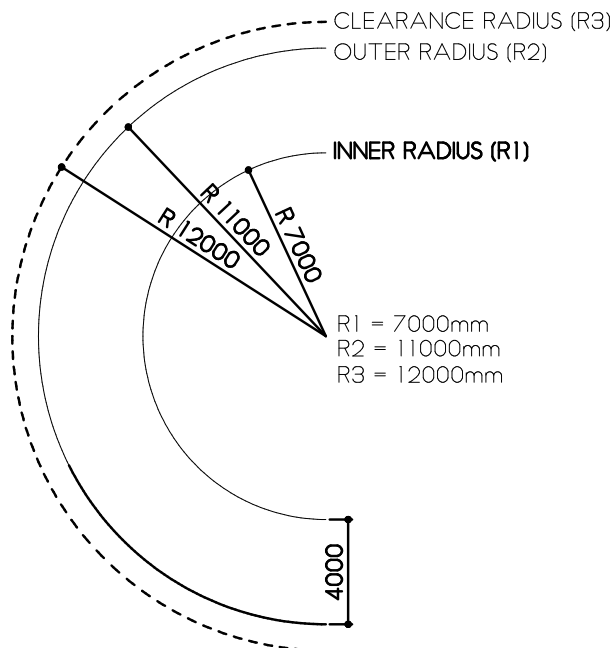
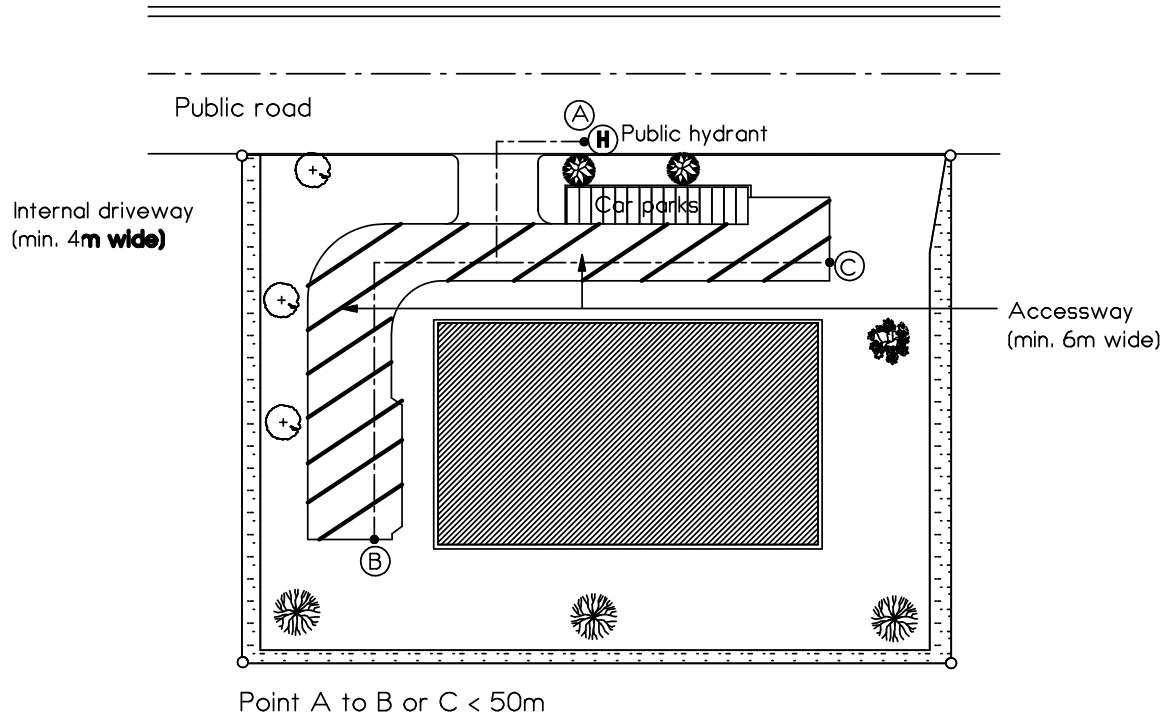
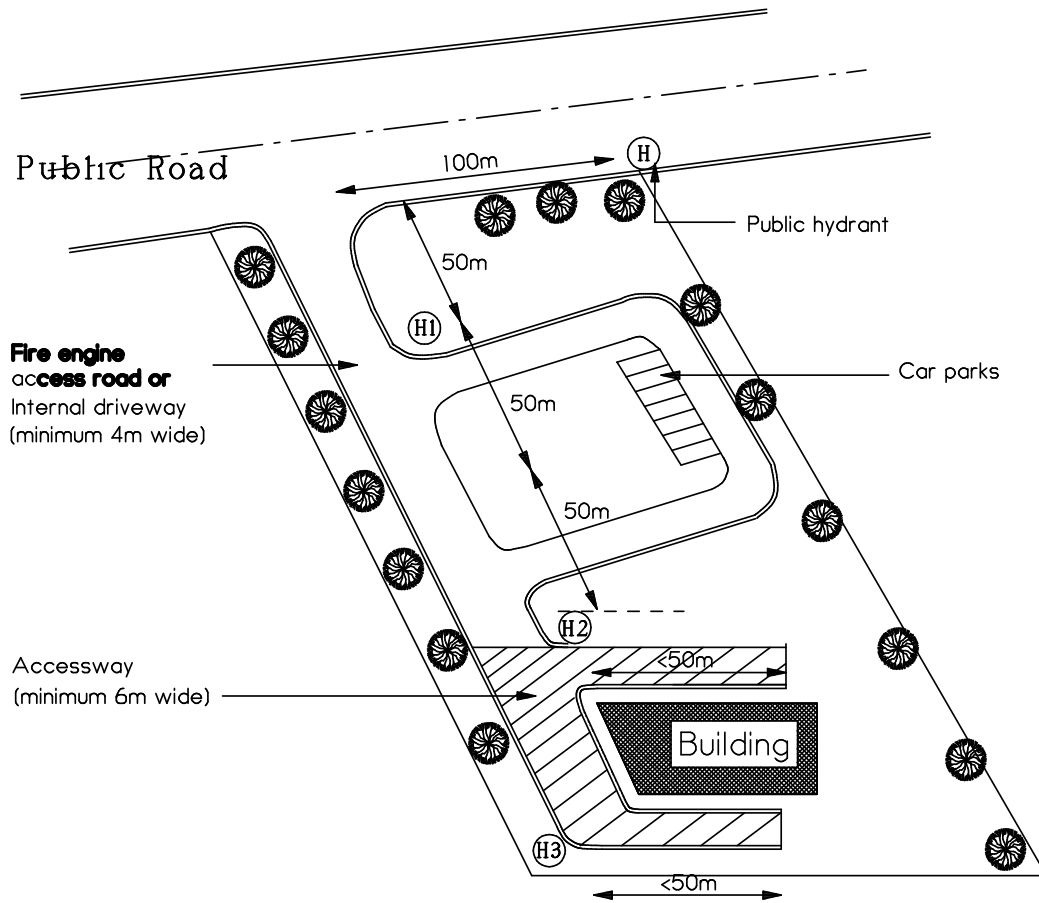

Diagram 2.4.4.1(a) - Provision of Private Hydrant



Every part of a fire engine access road and/or an accessway in a private lot shall be within an unobstructed distance of 50m from a hydrant. Where a public hydrant conforming to such requirement is not available, private hydrant(s) shall be provided.

Diagram 2.4.4.1(b) - Provision of Private Hydrant



(H1) Provision of this hydrant can be waived if the adjoining land is used as landscape or open space only

In situation where more than one private hydrants are required, the hydrants shall be located along the fire engine access road and/or an accessway such that every part of the access road and/or accessway is within an unobstructed distance of 50m from any hydrant.

SECTION 2.5 FIRE FIGHTING SYSTEMS IN STATIONS

ROOT OBJECTIVES

The primary intentions of this section are encapsulated in the following statements:-

- R2.5.1 Provide appropriate and adequate fire-fighting facilities for occupants first response to fire occurrence.
- R2.5.2 Provide appropriate and adequate fire-fighting facilities for fire-fighters to conduct their fire-fighting operations.
- R2.5.3 Provide appropriate and adequate means of alerting occupants and locating of the fire by fire-fighters.
- R2.5.4 Provide, where appropriate, adequate fire protection systems commensurate with the level of fire safety intended for the station.

SUB-OBJECTIVES

The following criteria define the conditions necessary to fulfil the intentions of this section:-

- S2.5.1 Provisions for first response to fire occurrence by occupants shall be installed appropriate to:-
 - (i) the nature of the hazard; and
 - (ii) the station layout; and
 - (iii) the use of the space.
- S2.5.2 Fire-fighting facilities, including the necessary accessories for effective fire-fighting operations shall be installed appropriate to:-
 - (i) the nature of the hazard; and
 - (ii) the anticipated fire severity; and
 - (iii) the station layout; and
 - (iv) the height above and the depth below ground of the station; and
 - (v) the use of the space.

S2.5.3 Fire protection systems to control the spread of fire shall be installed appropriate to:-

- (i) the nature of the hazard; and
- (ii) the anticipated fire severity; and
- (iii) the fuel and storage configuration; and
- (iv) the height above and the depth below ground of the station; and
- (v) the use of the space.

S2.5.4 Provisions for appropriate and adequate detection and warning systems to locate the fire and alert occupants and alarm monitoring agents shall be installed appropriate to:-

- (i) the nature of the hazard; and
- (ii) the anticipated fire severity; and
- (iii) the station layout; and
- (iv) the use of the space.

SECTION 2.5 FIRE FIGHTING SYSTEMS IN STATIONS

2.5.1 GENERAL

- 2.5.1.1 Air shafts (as defined in Cl.2.6.1.4) need not be provided with manual call points, alarm bells, detectors, sprinklers, fire extinguishers or hoses.
- 2.5.1.2 Buffer areas need not be provided with detectors, sprinklers or hoses.
- 2.5.1.3 Dry mains landing valves, hoses and detectors where required need only cover the fans in tunnel ventilation fan rooms.
- 2.5.1.4 Air plenums which do not contain combustible materials need not be provided with fire protection.
- 2.5.1.5 The fire fighting systems are permitted to receive Newater from PUB mains.

2.5.2 PORTABLE FIRE EXTINGUISHERS

- 2.5.2.1 Fire extinguishers shall be provided within the station, commercial spaces and plantrooms at ground level entrances. Pedestrian underground or aboveground links leading to station entrances and services ducts need not be provided with fire extinguishers.
- 2.5.2.2 Portable fire extinguishers where required to be provided shall be constructed in conformity with specifications stipulated under SS 232 Specification for Portable Extinguishers.
- 2.5.2.3 All portable fire extinguishers where required to be provided shall be charged, tested and maintained in fully operational conditions and properly tagged in conformity with requirements in SS CP 55 Code of Practice for Use and Maintenance of Portable Fire Extinguishers.
- 2.5.2.4 Classification of portable fire extinguishers provided shall be selected in accordance with criteria specified under SS CP 55 such that the nature of processes and contents within the building concerned can be effectively protected. The size, quantity and siting of these portable fire extinguishers shall comply with the requirements in SS CP 55 under the respective class of occupancy hazard.

Type, size and siting

| | |
|--|--|
| | |
| <p>2.5.2.5 Portable fire extinguishers provided shall be installed and conspicuously marked in accordance with requirements by SS CP 55.</p> | <p>Installation, marking</p> |
| <p>2.5.3 DRY RISING MAINS</p> | |
| <p>2.5.3.1 (a) Dry rising mains shall be installed in above-ground station where the habitable height is more than 10m.</p> <p>Exception: Open station with all trainways located at external façade and fire engine accessway available alongside the trainways.</p> <p>(b) Every basement level shall be provided with dry mains.</p> | |
| <p>2.5.3.2 Separate dry mains shall be provided for the stations and underground trainways.</p> | |
| <p>2.5.3.3 Basement commercial spaces on commercial floors shall be provided with dry mains in compliance with SS CP29 except as herein modified:</p> <p>(a) Landing valves shall be provided such that any part within the basement commercial spaces is within 38m from a landing valve, the distance to be measured along a route suitable for the hoseline.</p> <p>(b) Position of landing valves shall be located in the following order of priority:</p> <p>(i) within fire-fighting/smoke-stop lobby;</p> <p>(ii) inside exit staircase;</p> <p>(iii) just outside the entrances of the basement commercial spaces.</p> <p>(c) Dry mains within the basement commercial spaces shall be at least 2-hr fire rated.</p> | <p>Basement commercial spaces on commercial floors</p> |

| | | Design |
|---------|--|--------|
| 2.5.3.4 | <p>The design of the dry mains in the station shall comply with requirements of SS 574 except as herein modified:</p> <ul style="list-style-type: none"> (a) <ul style="list-style-type: none"> (i) Landing valves shall be provided such that every part of each floor is within 68m from a landing valve—along a route suitable for the hose line. (ii) Lift motor rooms at/near entrances, underplatform services ducts, cable chambers, electrical rooms, air locks, air plenums, vent shafts, and pedestrian subway/bridge without commercial activities are exempted from sub-clause (i) above. (b) Position of landing valves shall be located in the following order of priority: <ul style="list-style-type: none"> (i) within fire-fighting/smoke-stop lobby; (ii) inside exit staircases. (c) Landing valve, where provided at the centre of train platform, shall be charged with water when any one of the dry mains at the ends of the platform is charged with water. (d) Dry mains need not be fire rated. The dry mains shall not be routed through smoke exhaust shafts, shops and high hazardous areas. (e) Each dry mains can serve more than 2 landing valves per floor provided: <ul style="list-style-type: none"> (i) There are at least 2 dry mains, one at each end of the station; (ii) The nominal bore is 150mm with a 4-way breeching inlet; and (iii) The total pressure loss at any landing valve is not more than 4 bars at 38 l/s. (f) The metal box for the breeching inlet need not be provided if the inlet is installed in recesses and protected from mechanical damages. A glass-fronted cover/door complying with the requirements of SS 574 shall be provided. | |

- 2.5.3.5 The dry mains' breaching inlets shall be within 18m and visible from the nearest fire engine accessways. Where the breaching inlets are located at the vent shafts, the design shall be such that the fire-fighting operation near the breaching inlets is not affected by smoke exhausting from the vent shafts.
- 2.5.3.6 Connecting pipe between the inlets and the vertical run of the mains, where applicable, shall be kept as short as possible.
- 2.5.3.7 Breaching inlets shall be appropriately numbered and labelled as shown below. The total number of dry mains provided for the station (including tunnels) shall be indicated. The wording shall be white on a contrasting background.

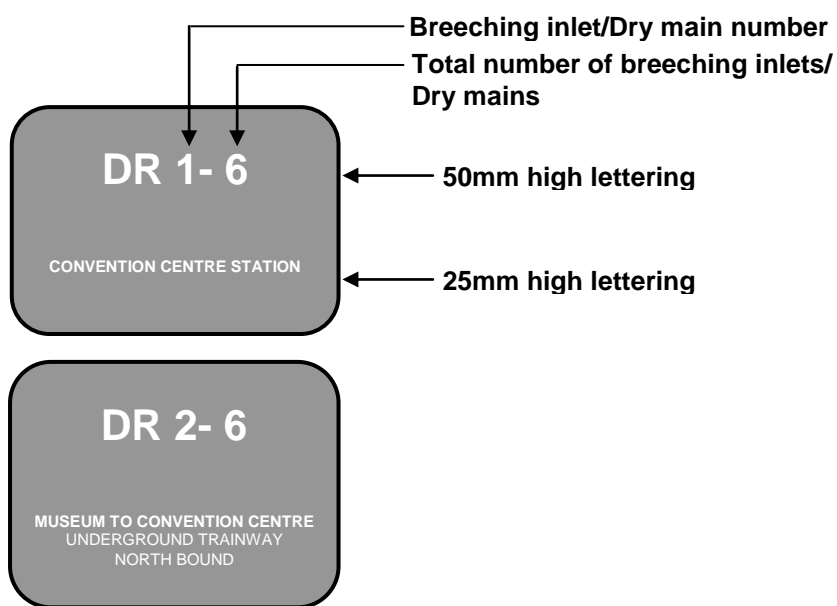

- 2.5.3.8 Standby fire hose shall be provided in accordance with APPENDIX F. Two standby fire hoses shall be provided at each of the landing valves, but one standby fire hose is also acceptable if coverage is adequate.

Breeching inlets

Standby fire hose

2.5.4 HOSE REELS

2.5.4.1 Hose reels shall be provided throughout the station including the underground links leading to the underground station entrances except :

- (a) buffer areas (including plant rooms within these areas), station platforms and above-ground outdoor cooling tower enclosure;
- (b) ground level entrances with no habitable rooms;
- (c) cable chambers and underplatform services ducts.

2.5.4.2 Water supply, location and details of installation for hose reels shall comply with the requirements of SS 574 except as herein modified:

- (a) Hose reels shall be located in the following order of priority:
 - (i) adjacent to exits and protected lobbies;
 - (ii) along exit routes; and
 - (iii) within rooms.
- (b) Where the hose reel and automatic sprinkler systems share the same water tank, the hose reel tap-off points shall be above the sprinkler system's reserve capacity.

2.5.4.3 The use of copper or stainless steel pipings are permissible for the connection of the hose reel to the PUB mains.

2.5.5 ELECTRICAL FIRE ALARM SYSTEM

2.5.5.1 An automatic fire alarm system shall be provided in the station.

2.5.5.2 The fire alarm system shall comply with the requirements of the SS CP 10 Code of Practice for The Installation and Servicing of Electrical Fire Alarm Systems except as herein modified:

- (a) For underground station without Fire Command Centre (FCC), the main alarm panel shall be located in the firemen's staircase at ground level. All fire alarm signals shall also be transmitted to the Passenger Service Centre (PSC), if provided;
- (b) Buffer area, air lock, air plenum, above-ground outdoor cooling tower enclosure and naturally cross-ventilated public areas need not be provided with detectors.
- (c) Station public areas shall not be provided with alarm bells and manual call points. Ancillary areas of aboveground light rapid transit (LRT) stations shall not be provided with alarm bells.
- (d) Alarm bells in the commercial spaces on the commercial floor shall only sound if sprinklers, detectors or manual call points are activated within the commercial spaces.
- (e) In addition to the alarm bells, sufficient visual alarm devices e.g. beacon lights shall be provided in but not limited to the following plantrooms where the background noise is excessive:
 - (i) Environment control system plantroom;
 - (ii) Tunnel ventilation fan room;
 - (iii) Underplatform exhaust fan room;
 - (iv) Smoke extract fan room;
 - (v) Civil Defence generator room; and
 - (vi) Civil Defence cooling tower room.
- (f) For fire detection in station public areas, linear heat detectors of the optic fibre type and optical beam line-type detectors can be considered in the concealed ceiling spaces and under the ceilings respectively. Where linear heat detectors are used, the coverage shall be equivalent to the point-type detectors.

| | | |
|---------|--|--------------------------------------|
| | | |
| 2.5.5.3 | All automatic systems activated by the fire alarm shall be connected directly to the fire alarm system. | |
| 2.5.5.4 | Manual Call Points | |
| | (a) Manual call points shall be so located that no person need travel more than 30m to activate the alarm. | Manual call points |
| | (b) Manual call points in the ancillary area shall be located along exit routes and next to hose reels, where provided. | |
| | (c) Manual call points should be fixed at a height of 1.2 - 1.4m above the floor and shall be located at easily accessible and conspicuous positions free from obstructions. The installation of the sounding device shall be in accordance with SS CP 10. | |
| | (d) Wordings on call points shall comply with SS 508. | |
| | (e) Manual call points and alarm bells are not required to be provided in the cable chambers, underplatform services ducts and above-ground outdoor cooling tower enclosure. | |
| 2.5.5.5 | The fire alarm sounder shall have a sound that is readily distinguishable from any other alarm system. | |
| 2.5.5.6 | The system shall be connected to the OCC. | Connection to fire station |
| 2.5.5.7 | Where sprinkler system is required by this Standard, provision of automatic thermal/smoke detectors in sprinkler protected premises will be exempted except where such detectors are required to activate or operate the sprinkler or other systems. | Sprinkler protected building |
| 2.5.5.8 | Separate fire alarm systems may be provided in stations with multiple transit lines (Cl.2.8.2.3). | Stations with multiple transit lines |
| 2.5.5.9 | A summary fire alarm signal for stations with interchange-link shall be provided in accordance with Cl.2.8.3.3. | Fire alarm signal |

2.5.6 SPRINKLER INSTALLATION

2.5.6.1 The following shall be provided with an automatic sprinkler system:

- (a) Whenever compartmentation requirements under Cl.2.3 of this Standard cannot be complied with.
- (b) All basement storeys shall be provided with an automatic sprinkler system irrespective of compartment size. Where the upper storeys of the station is fully compartmented from the basement storey, the requirement for provision of an automatic sprinkler system for floors above the basement shall be considered separately.

General

Basement

The following areas are exempted from sprinklered protection:

- (i) Public areas. However, the public areas shall be protected in accordance with Cl.2.5.5.
- (ii) Civil Defence (CD) rooms not containing storage.
- (iii) Station Manager Room (SMR) – where SMR is adjacent to Passenger Service Centre (PSC), the door separating the two rooms shall be provided with a vision panel, and the door shall be provided with access management system that will release/unlock the door automatically by fire alarm or by a manual release/unlock device located in PSC, and portable fire extinguisher shall be provided in each room.
- (iv) Buffer areas.
- (v) Escalator pits at entrances of multi-entry stations.
- (vi) Travellator trusses (only for travellators in an air-conditioned environment) to be free of debris.
- (vii) Air lock/plenum which does not contain combustible materials.

2.5.7 LIFTS

2.5.7.1 Lifts (including fire lifts) shall be installed in accordance with the SS 550 Code of Practice for Installation, Operation and Maintenance of Electric Passenger and Goods Lifts except as modified in APPENDIX J for the lift(s) in the station used for the safe evacuation of Persons with Disabilities (PWDs).

2.5.7.2 Notwithstanding the requirements in SS 550, in the event of power failure or power interruption in the normal (primary) power supply whereby a dual feeder power supply is provided, the supply to the lift(s) shall be automatically switched over to the other feeder and the lift(s) continue its normal operation without homing.

2.5.7.3 Emergency lift control during power failure and/or fire emergency for hydraulic lifts shall also comply with Cl.2.5.7.2 and the requirements of SS 550 respectively.

2.5.7.4 The power supply to the lift shall be connected to a sub-main circuit exclusive to the lift and independent of any other main or sub-main circuit. The power cables serving the lift installation shall be routed through an area of negligible fire risk shall be routed through an area of negligible fire risk.

2.5.7.5 Fire Lift

- (a) Underground stations exceeding 3 basement storeys shall be provided with at least one fire lift.
- (b) The fire lift shall be contained within a separate protected shaft or a common protected shaft containing other lifts subject to such other lifts being served at each storey by a fire-fighting lobby.
- (c) A fire lift shall have access to every habitable floor above or below the designated floor and shall be adjacent and accessible to an exit staircase and be approached by a fire-fighting lobby at each storey.
- (d) A fire lift shall be provided with an operational feature that would enable firemen to cancel first or earlier call which had been inadvertently made to the fire lift during an emergency.
- (e) A lift mainly intended for the transport of goods shall not be designated as a fire lift.

Hydraulic lift

Fire lift

Table 2.5A COMPARTMENTATION AND FIRE PROTECTION REQUIREMENTS

| Usage (1) | Non-sprinkler protected building (2) | | Sprinkler protected building (3) | | |
|---|--------------------------------------|---------------------|----------------------------------|---------------------|-------------------|
| | Compartmentation (2a) | Door rating (2b) | Compartmentation (3a) | Door rating (3b) | Sprinkler (3c) |
| Store room | 1-hr | 1-hr | N | N | S |
| AHU room | N | N | N | N | S |
| Low voltage switch room | 2-hr | 2-hr | 2-hr | 2-hr | EX |
| High voltage switch room | 2-hr | 2-hr | 2-hr | 2-hr | EX |
| Transformer room (oil type) ¹ | 2-hr | 2-hr | 2-hr | 2-hr | EX |
| Fuel/Oil tank room | 4-hr | 4-hr | 4-hr | 4-hr | S |
| Generator room | 4-hr | 4-hr | 4-hr | 4-hr | S |
| Electric lift motor room ² | 2-hr | 2-hr | 2-hr | 2-hr | EX |
| Hydraulic lift motor room ² | 2-hr | 2-hr | 2-hr | 2-hr | S |
| Battery room (for essential equipment) | 2-hr | 2-hr | 2-hr | 2-hr | EX |
| Fire pump/tank room | 2-hr | 2-hr | 2-hr | 2-hr | S |
| Fire command centre | 2-hr | 2-hr | 2-hr | 2-hr | S |
| MDF room, PABX room | N | N | 2-hr | 2-hr | EX |
| | | | N | N | S |
| Public toilet ³ | N | N | N | N | S |
| Commercial space | 2-hr | 2-hr | 1-hr | 1-hr | S |
| Ticket vending machine room ³ | N | N | N | N | EX |
| Passenger Service Centre (PSC) ³ | N | N | N | N | EX |
| Station Manager Room (SMR) ³ | N | N | N | N | S ¹¹ |
| Ticket sales office ³ | N | N | N | N | S |
| General purpose office ⁴ | N | N | N | N | S |
| Staff room ⁴ | N | N | N | N | S |
| Staff toilet/locker room ⁴ | N | N | N | N | S |
| Maintenance office ⁴ | N | N | N | N | S |
| Bin centre ⁵ | 2-hr | 2-hr | 2-hr | 2-hr | S |
| Tunnel ventilation fan room ⁶ | 2-hr | 2-hr | 2-hr | 2-hr | EX |
| ECS plant room | 2-hr | 2-hr | 2-hr | 2-hr | S |
| Electrical room | 2-hr | 2-hr | 2-hr | 2-hr | EX |
| Electrical closet | N | N | N | N | EX |
| Essential fan room ⁷ | 2-hr | 2-hr | 2-hr | 2-hr | S |
| Uninterruptible power supply room | 2-hr | 2-hr | 2-hr | 2-hr | EX |
| Pneumatic platform screen door room | 2-hr | 2-hr | 2-hr | 2-hr | S |
| Underplatform Services Duct ⁸ | 2-hr | 2-hr | 2-hr | 2-hr | EX |
| Civil defence room with storage | 2-hr | 2-hr | N | N | S |
| Civil defence room without storage | N | N | N | N | EX |
| Supply air shaft ⁹ | 2-hr | 2-hr | 2-hr | 2-hr | -- |
| Exhaust air shaft ⁹ | 2-hr | 2-hr ¹⁰ | 2-hr | 2-hr ¹⁰ | -- |

(Note: Essential equipment includes communication equipment, signalling equipment, uninterruptible power supply/emergency power supply charger/rectifier and HV/LV switchgears which are critical for the operation of trains, the emergency fire safety equipment and the emergency evacuation of commuters.)

- EX Sprinkler system is exempted from the corresponding area provided that the area is fitted with an automatic fire alarm system installed according with SS CP 10
- N No specific requirement on compartmentation
- S Sprinkler system has to be extended into such rooms

- 1 4-hr compartmentation if flammable liquids are used. Refer to Cl. 2.3.2.4(g)(i)
- 2 Openings for ropes and cables shall be kept as small as practicable
- 3 Wall/door separating the room and non-public area shall have at least 2-hr fire rating
- 4 Wall/door separating the room and public area shall have at least 2-hr fire rating
- 5 Compartmentation and sprinkler protection are not required if it is a stand-alone structure i.e. not adjoining or below transit structure(s)
- 6 Motorised dampers separating the room and the trainways need not have fire rating
- 7 Except as modified in Cl. 2.5.6.2(e)
- 8 The underplatform services duct (UPSD) shall also be divided longitudinally into two sections by a 2-hour fire-rated wall so that the two electrical feeders carrying electrical power supply for the RTS system are physically separated
- 9 No detectors are required in these air shafts
- 10 The door shall also be a smoke check door
- 11 Sprinkler is exempted where SMR meets the requirements of cl.2.5.6.1(b)(iii)

SECTION 2.6 STATION SMOKE CONTROL AND MECHANICAL VENTILATION SYSTEMS

ROOT OBJECTIVES

The primary intentions of this section are encapsulated in the following statements:-

- R2.6.1 Maintain tenable conditions for evacuation of occupants.
- R2.6.2 Provide smoke management in the station for fire-fighting operations.

SUB-OBJECTIVES

The following criteria define the conditions necessary to fulfil the intentions of this section:-

- S2.6.1 Provisions for ventilation for life safety purposes such that, in the event of a fire, evacuation routes are maintained:-
 - (i) below thermal threshold for human tenability; and
 - (ii) at visibility levels adequate for occupant evacuation; and
 - (iii) below toxicity threshold for human tenability; and
 - (iv) not impeding the movement and evacuation of occupants.for the period of time required for evacuation.
- S2.6.2 Provisions for ventilation to maintain safe conditions in the means of escape for evacuees for the period of time required for evacuation.
- S2.6.3 Provisions for appropriate smoke management system in the station to facilitate fire-fighting operation.
- S2.6.4 Provisions for adequate ventilation for equipment emitting flammable vapour, to prevent undesirable accumulation of such flammable vapour.

S2.6.5 The installation and operation of the mechanical ventilation systems shall

- (i) have minimal contribution to the spread of fire and smoke in the station; and
- (ii) have no adverse effects on the operation of other life safety or fire suppression systems.

S2.6.6 Provisions for appropriate and adequate ventilation to

- (i) rooms housing essential fire-fighting facilities for continual operation; and
- (ii) fire command centre.

S2.6.7 Provisions to prevent re-circulation of smoke into the system due to the effects of a fire in the station, with considerations for:-

- (i) air intake openings; and
- (ii) station entrances; and
- (iii) station and / or trainway surface openings; and
- (iv) adjacent structures and property uses.

**SECTION 2.6
STATION SMOKE CONTROL AND
MECHANICAL VENTILATION SYSTEMS**

2.6.1 GENERAL

2.6.1.1 Fans forming part of a fire rated duct shall also be enclosed in the same fire rated enclosure.

2.6.1.2 Ductwork not serving smoke control fan rooms shall not pass through the smoke control fan rooms.

2.6.1.3 PVC pipes are prohibited in underground stations, except PVC pipe sleeves and condensate drain pipes for air-conditioning units as stipulated in Cl.2.3.15.11 of this Standard.

2.6.1.4 Fresh/exhaust air of the station's smoke control and mechanical ventilation systems can be taken from/discharge to the intake/exhaust air shafts (shown shaded in *Diagrams 2.6.1.4(a) and 2.6.1.4(b)*) respectively of the underground station.

2.6.1.5 The intake and exhaust air shafts shall be positioned or protected to prevent re-circulation of smoke into the system through air intake openings, station entrances and other surface openings. Adjacent structures and property uses also shall be considered.

2.6.1.6 Primary and secondary power supply shall comply with Cl.4.1.3 of this Standard.

2.6.1.7 Where replacement air is taken from doorways at station entrances, devices or other measures shall be incorporated to admit replacement air upon activation of the emergency ventilation system to achieve the design requirements during operating hours and non-operating hours when the station is closed for passenger service.

**2.6.2 AIR-CONDITIONING & MECHANICAL
VENTILATION SYSTEMS**

2.6.2.1 Where air-conditioning system is provided in lieu of mechanical ventilation system during emergency, all the requirements specified in this Standard for the mechanical ventilation system shall apply to the air-conditioning system.

Smoke control fan rooms

PVC pipes

Air shafts

Re-circulation of smoke

Power supply

| | | |
|---------|--|--|
| | | |
| 2.6.2.2 | <p>The mechanical ventilation systems for stations and staircase pressurisation where required under Cl.2.2.5.6 shall comply with SS 553 Code of Practice for Mechanical Ventilation and Air-conditioning in Buildings, unless as herein modified.</p> | |
| | <p>(a) The mechanical ventilation of the firemen’s staircase shall be maintained at higher positive pressure with respect to the mechanical ventilation system of the adjacent fire-fighting lobby.</p> | Firemen’s staircase |
| | <p>(b) Duct coverings, duct linings and flexible connection materials shall be non-combustible. However, if it is necessary to use combustible materials, it shall have a surface flame spread rating of not lower than Class 0.</p> | Duct covering, duct lining and flexible connection |
| | <p>(c) (i) Thermal insulation materials for pipework together with vapour barrier linings and adhesives shall have a surface flame spread of not lower than Class 0.</p> | Pipework Insulation |
| | <p>(ii) Notwithstanding the requirements of sub-clause (c)(i), the use of plastic and foam rubber insulation materials of a lower classification is permissible only in above-ground stations if:</p> <ul style="list-style-type: none"> * The material is the self extinguishing type; * The insulation material is covered by or encased in a metal sheath or hybrid plaster or other non-combustible cladding material. <p>[Note: Any opening in the element of structure or other part of a building penetrated by the pipework shall be effectively fire-stopped by replacement of the insulation material at the junction of penetration with fire resistant material having equal fire rating.]</p> | Plastic and foam rubber insulation |
| | <p>(d) Rooms having no other usage than housing air handling equipment or package units and their associated electrical controls are not regarded as areas of high risk.</p> | Air handling unit rooms |



- (e) Where the supply air duct serving the exit staircase has to penetrate the staircase enclosure, the portion of the duct where it traverses outside the staircase shall be enclosed in masonry construction or drywall complying with Cl.2.3.8.7(c) of at least the same fire resistance as the elements of structure and it shall not be fitted with fire dampers.
- (f) Where duct risers are required to be enclosed in protected shafts, the protected shafts shall be enclosed in masonry construction or drywall complying with Cl.2.3.8.7(c).
- (g) Battery rooms shall be ventilated to maintain the average hydrogen concentration by volume in the room below 2%.
- (h) Magnetic (short circuit) trips are permitted for use in motor circuits of essential mechanical ventilation systems and equipment. Moulded Case Circuit Breakers (MCCBs) with magnetic release only are permitted for use in lieu of High Rupturing Capacity (HRC) fuses.

2.6.2.3 Fire dampers shall not be fitted in the following locations:

- (a) Openings for ducts of emergency ventilation systems in walls of ventilation shaft.
- (b) Anywhere in an air pressurising system.

2.6.2.4 Vent Openings in Lift Hoistway

- (a) The protected lift shaft shall be vented in accordance with SS 550 Code of Practice for Installation, Operation and Maintenance of Electric Passenger and Goods Lifts. The vents shall be so arranged as to induce exhaust ventilation of the shaft. Where vents could not be provided because of the location of the lift shaft, ventilation duct protected by drywall complying with Cl.2.3.8.8(b) serving as ventilation of the shaft may be provided instead. If the duct is not to be fire rated, fire dampers shall be provided to the duct at the wall of the lift shaft, provided such relaxation shall not apply to shaft containing fire lift.

Prohibition of fire dampers

Hoistway ventilation

- (b) Where the lift shaft is not a protected shaft, the lift hoistway shall be adequately ventilated at the top of the shaft by means of one or more permanent openings having a total unobstructed area of not less than 0.1m^2 for each lift in the shaft.

2.6.3 **ENGINEERED SMOKE CONTROL SYSTEM**

- 2.6.3.1 Engineered smoke control system shall be provided in basement commercial space on commercial floor and shall comply with SS 553 Code of Practice for Mechanical ventilation and air-conditioning in buildings.
- 2.6.3.2 The engineered smoke control system need not be a dedicated system.
- 2.6.3.3 In lieu of smoke detectors, linear heat detectors of the optic fibre type can be used to activate the engineered smoke control systems in non-public areas.

2.6.4 **SMOKE PURGING SYSTEM**

2.6.4.1 **Underground Station Public And Ancillary Areas**

- (a) Smoke purging system shall be provided in the following areas:-
 - (i) Station public areas
 - (ii) Corridors of ancillary areas in basement.Except the following:-
 - (iii) Corridors serving only ticketing machine rooms, staff offices, staff toilets, cleaner's stores and not more than one plantroom.
 - (iv) Corridor at buffer areas.
- (b) For underground station with enclosed public areas above ground, the smoke purging system shall be extended to these public areas.

Station public areas and corridors

- (c) The smoke purging system design shall comply with the following requirements:
- (i) Minimum of two (2) sets of smoke purging fans shall be provided. Each fan shall be capable of achieving minimum 50% of the design extraction/supply air flow rates.
 - (ii) Velocity of induced air across the doorways and the passageways shall not exceed 5 metres per second. When the replacement air is taken through inlet air ventilators or doorways, devices shall be incorporated to automatically open such inlet ventilators and doors to admit replacement air upon activation of the emergency ventilation system.
 - (iii) Smoke extract grilles shall be adequately distributed to ensure that there is no stagnant region within the area of operation.
 - (iv) Smoke purging duct passes through other fire compartment of higher rating, the duct shall be constructed to have the rating as that of the compartment.
 - (v) Supply and exhaust fans shall be electrically interlocked such that the failure of the exhaust fan shall automatically shut down the corresponding supply fan.
 - (vi) The purge rate shall be at least 9 air changes per hour.
 - (vii) The smoke purging system shall be activated automatically by the station fire alarm system. In addition, a remote manual start-stop switch shall be located at fire command centre, or in the absence of a fire command centre in the station, at the main fire alarm panel on the first storey. Visual indication of the operational status of the smoke purging system shall also be provided with this remote control.
 - (viii) Horizontal ducts shall be fabricated from heavy gauge steel (1.2 mm thick).

Design of
smoke purging
system

- (ix) The exhaust fan shall be capable of operating effectively at 250°C for 2 hours and supplied from a secondary source of supply.
- (x) Replacement air shall be provided and if it is supplied by a separate mechanical system, such a system shall be connected to a secondary source of power.
- (d) The smoke purging system need not be a dedicated system. Where dampers are used to direct the smoke for the smoke purging system, motorised smoke dampers shall be used.
- (e) Shops as permitted in Cl. 2.1.3 are not required to be provided with smoke control system.
- (f) Public area outside the commercial space shall be provided with smoke purging system as shown in *Diagram 2.6.4.1(f)*.
- (g) The smoke purging system in the station public area shall be automatically activated by detectors located in the station public areas. Similarly the smoke purging system in a non-public area shall be activated by the fire alarm signals from that particular non-public area.

Shops

2.6.5 **UNDERGROUND AND ENCLOSED STATION
TRAINWAY EMERGENCY VENTILATION SYSTEM**

2.6.5.1 An emergency ventilation system shall be designed for a train fire in an underground and enclosed stations trainway as follows:

- (a) Provide a tenable environment along the path of egress from the fire incident.
- (b) Be capable of reaching full operational status in 120 seconds or less.
- (c) The emergency ventilation fans shall be provided such that in the event one of the fans is not operational, the other fan(s) shall be capable of maintaining the system design.
- (d) The replacement air velocity against the direction of escape at doorways and escape routes shall not exceed 5m/s

Replacement
air

2.6.5.2 The design shall encompass the following:

- (a) The heat release rate from a vehicle and any other combustible materials (if permitted) in the trainways that could contribute to the fire load, subject to the approval of the relevant authority.
- (b) The rate of fire growth.
- (c) Station and trainway geometries.
- (d) Fans, shafts and devices for directing air.
- (e) Predetermined procedures for initiating quick response from the OCC during fire.

2.6.5.3 Fans not designed to function during fire shall shut down automatically upon activation of the emergency ventilation system unless it can be proven that the emergency air flow is not jeopardised or conflicted with.

2.6.5.4 Emergency ventilation fans, their motors and all related components exposed to the exhaust airflow shall be capable of operating in an atmosphere of 250°C for a minimum of 2 hours.

2.6.5.5 Emergency ventilation fan motors shall be designed to achieve their full operating speed in 30 seconds or less from a stopped position when started across the line and in 60 seconds or less for variable speed motors

2.6.5.6 Local fan motor starters and related operating control devices shall be located as far away from the direct air stream of the fans. Thermal overload protective devices shall not be used on motor control of fans used for emergency ventilation

2.6.5.7 Operation of the emergency ventilation system shall be initiated from the Operation Control Centre (OCC). Local controls, located in the Passenger Service Centre (PSC) of the station, shall be provided and be allowed to control the emergency ventilation system only when the authority is delegated from the OCC to the station PSC.

2.6.5.8 When the replacement air is taken through inlet air ventilators or doorways, devices shall be incorporated to automatically open such inlet ventilators and doors to admit replacement air upon activation of the emergency ventilation system.

Fail-safe
replacement
air

2.6.5.9 Smoke reservoirs shall be provided above the station trainways and platform screen doors (PSD). The materials used for the construction of the smoke reservoirs shall be able to withstand the designed highest temperature from a train fire or having a fire resistance rating of not less than 2 hours.

Smoke
reservoirs

Diagram 2.6.1.4(a) - Fresh/exhaust air taken from/discharged to intake/exhaust air shaft

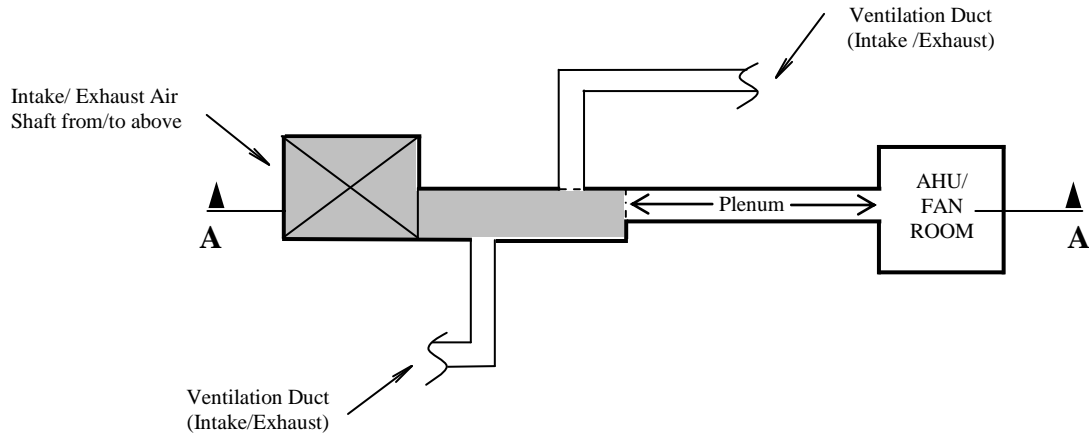

PLAN VIEW OF VENTILATION DUCTS CONNECTION TO AIR SHAFTS (SHADED)

Diagram 2.6.1.4(b) - Section View

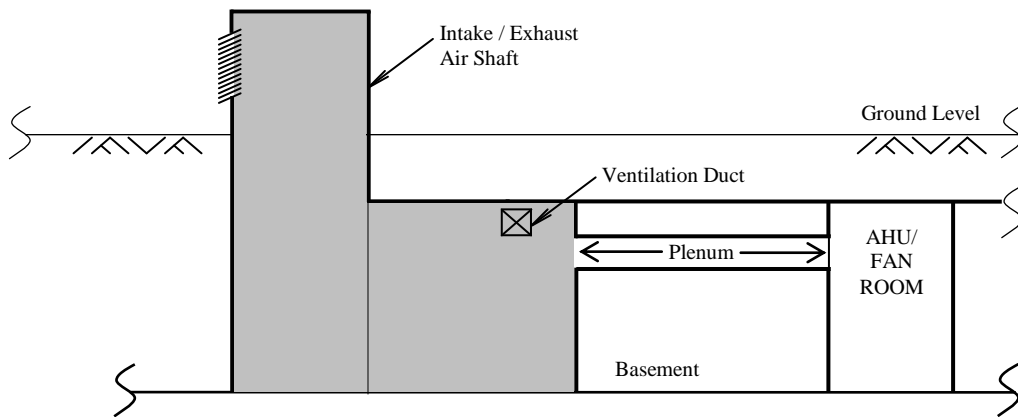

SECTION A-A

Diagram 2.6.4.1(f) - Public area outside the commercial space of station shall be provided with smoke purging system

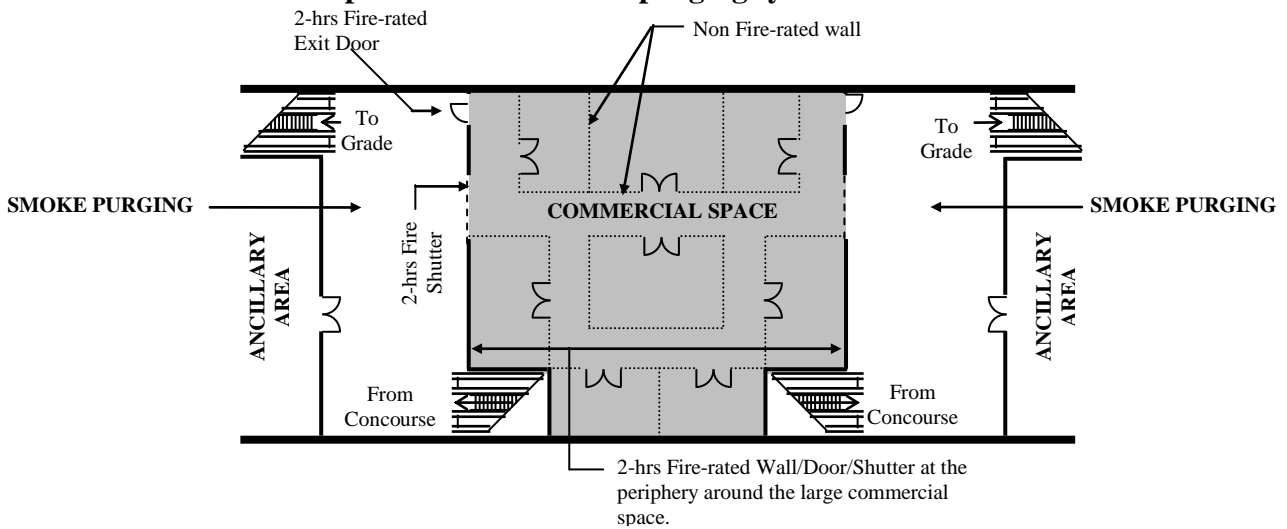

COMMERCIAL FLOOR OF STATION

SECTION 2.7 OTHER SYSTEMS IN STATIONS

ROOT OBJECTIVES

The primary intentions of this section are encapsulated in the following statements:-

- R2.7.1 Enable the safe escape of occupants from a station during a fire emergency by having adequate and appropriate
 - (i) lighting; and
 - (ii) means of identifying exit routes.
- R2.7.2 Enable the continual use of fire-fighting facilities by providing adequate and appropriate lighting for the duration of the fire emergency.
- R2.7.3 Enable effective fire fighting by providing means of communication for fire-fighters in a station during a fire emergency.
- R2.7.4 Provide effective means of communication for occupants and transit operators in the event of a fire.
- R2.7.5 Provide fire command facilities and means of navigation for effective fire fighting in a station.

SUB-OBJECTIVES

The following criteria define the conditions necessary to fulfil the intentions of this section:-

- S2.7.1 Provisions for lighting at appropriate locations to enable occupants to have adequate visibility for safe evacuation, with considerations for:-
 - (i) the use of the space; and
 - (ii) the distance of travel to common escape routes.

- S2.7.2 Provisions for adequate and appropriate means to enable occupants to
- (i) clearly identify exit locations; and
 - (ii) be guided to such exit locations
- during a fire emergency in the station.
- S2.7.3 Provisions for adequate and appropriate means of relaying information and instructions to the occupants during a fire emergency in a station.
- S2.7.4 Provisions for adequate and appropriate means of communication for fire-fighting and rescue operations in the station.
- S2.7.5 Provisions for adequate and appropriate means of communication between occupants and transit operators for reporting of fire.
- S2.7.6 Provisions for adequate and appropriate means of communication between station and Operation Control Centre (OCC).
- S2.7.7 Provisions for adequate and appropriate means to enable fire-fighters to navigate within the station.
- S2.7.8 Provisions for adequate and appropriate command and control facilities for fire-fighters.

**SECTION 2.7
OTHER SYSTEMS IN STATIONS**

2.7.1 EXIT LIGHTING AND EXIT SIGN

2.7.1.1 Exit Lighting

Exit lighting

- (a) Exits of all stations shall be provided with artificial lighting facilities to the satisfaction of the requirements under this Standard.
- (b) The minimum illuminance to be provided for all exits and the spacing for luminaires shall be in accordance with the requirements in SS 575 Code of Practice for the Installation and Maintenance of Emergency Evacuation Lighting and Power Supply Systems in Buildings.
- (c) The delay between the failure of the electrical supply to normal lighting and the energization of the exit lighting shall not exceed 1 second.

2.7.1.2 Emergency Lighting for Public Areas, Corridors and Lobbies

Emergency lighting for public areas, corridors & lobbies

- (a) Emergency lighting shall be provided in public areas, all corridors and lobbies.
- (b) The minimum level of illuminance, the spacing of luminaires and the maximum delay for emergency lighting required in this clause shall be the same as that for the exit lighting.

2.7.1.3 Emergency Lighting for Occupied Areas

Emergency lighting for occupied areas

- (a) Emergency lighting shall be provided in the occupied areas following the guidelines below:
 - (i) Along paths leading to corridors, lobbies and exits in all occupied areas where the direct distance from the entry point of the corridor, lobby or exit to the furthest point in the area concerned exceeds 13m; or
 - (ii) Over the whole of such area if there is no explicit paths leading to corridors, lobbies and exits.

- (b) Notwithstanding the requirements in (a) above, emergency lighting shall be provided in the following locations:
 - (i) Lift cars as stipulated in this Standard;
 - (ii) Fire command centres;
 - (iii) Generator rooms;
 - (iv) Fire pump rooms;
 - (v) Accessible services ducts and cable chambers, and
 - (vi) Areas of refuge within the station.
- (c) The minimum level of illuminance shall comply with the requirements in SS 575.
- (d) The delay between the failure of the electrical supply to normal lighting and the energization of the emergency lighting for occupied areas shall not exceed 15 seconds.

2.7.1.4 Emergency lighting for fire fighting facilities

- (a) Main and sub alarm panels, manual call points and fire fighting equipment shall be adequately illuminated at all times so that they can be readily located.
- (b) The minimum level of illuminance shall comply with the requirements in SS 575.
- (c) The delay between the failure of the electrical supply to normal lighting and the energization of the emergency lighting for fire fighting facilities shall not exceed 15 seconds.

2.7.1.5 Secondary Source of Power Supply

- (a) The delay for energization of the exit and emergency lighting systems between normal supply and the secondary source shall be as stipulated in the relevant clauses.
- (b) Duration of the secondary source of power supply shall comply with the requirements in SS 575.

Fire fighting facilities

Secondary source of power supply

| | |
|--|-------------------------|
| <p>(c) Location, arrangement and control, installation of electrical wiring of the secondary source of supply, be it in the form of battery, standby generator, inverter or other accepted equipment, shall comply with the requirements in SS 575.</p> | |
| <p>2.7.1.6 All exit and emergency luminaires required by this Standard shall be of approved type as specified in SS 575.</p> | Luminaries |
| <p>2.7.1.7 Exit and Directional Signs</p> | |
| <p>(a) The entrance to every exit on every floor shall be clearly indicated by an exit sign placed over the exit door. Such signs shall be placed so as to be clearly visible at all times.</p> | |
| <p>(b) In long corridors, in open floor areas, and in all situations where the location of the exits may not be readily visible, directional signs shall be provided to serve as guides from all portions of the corridors or floors.</p> | Directional signs |
| <p>(c) Where the upper storey staircase is continuous with that serving the basement, appropriate signages, including pictorials shall be placed at strategic locations inside the staircase to direct occupants out of the station in times of emergency.</p> | |
| <p>(d) The legends, dimensions, design and installation of the exit signs and directional signs shall comply with SS 575 and SS 508. Externally illuminated exit signs shall comply with Cl.4.3.2.3 of SS 575.</p> | |
| <p>Exception: Externally illuminated exit signs in normally not occupied plantrooms need not be lighted at all times. However, during power failure, the emergency lighting in the rooms shall provide the required illumination to the signs.</p> | |
| <p>(e) The use of self-illuminating exit and direction signs with letters in green and powered by radioactive material may be allowed within the stations.</p> | Self-illuminating signs |
| <p>(f) Self-illuminating fire safety signs complying with BS 5499 Pt 2 can be used in lieu of emergency signs powered by electricity.</p> | |

- (g) Exit signs in metal enclosures with matt finishes are permitted with openings for venting, testing and inspection.

2.7.2 VOICE COMMUNICATION SYSTEM

2.7.2.1 One- and two-way emergency voice communication shall comply with requirements stipulated in SS 546 Code of Practice for Emergency Voice Communication Systems in Buildings.

Exception: Locations of remote handsets for two-way emergency voice communication system shall comply with Cl.2.7.2.7.

2.7.2.2 Except for lift cars, public address (PA) system, shall be provided throughout the station including all habitable rooms, basement floor areas, commercial spaces, escape staircases, all lobbies forming parts of the means of escape, main entrance lobby, corridors leading to exits, ancillary areas where people may be working, area of refuge and assembly areas in compliance with SS 546.

PA system

2.7.2.3 The Passenger Service Centre (PSC) or in the absence of which, the Operation Control Centre (OCC) shall be able to override the public address (PA) system in the commercial spaces on commercial floor.

2.7.2.4 The sounding of the alarm bells in the ancillary areas and the commercial spaces on commercial floor may be interrupted by messages made through the PA system. However, the alarm bells shall resume sounding not longer than 10s after the broadcast of messages.

2.7.2.5 The PA system shall interface with the fire alarm system. The station staff in the PSC (or OCC) shall manually acknowledge the fire alert within a period of 30 seconds when the fire alarm system is activated. The first fire alert shall automatically activate the multi-channel voice recorder to record all emergency voice communication. The recording shall stop if acknowledgement of the fire alert is carried out. In the event that the first fire alert has not been acknowledged, the emergency voice alarm system shall send a coded message throughout the station to advise operating staff that the fire alert has not been acknowledged. If the second fire alert is not acknowledged after 8 minutes, the emergency voice alarm system shall send a pre-recorded message throughout the station advising staff and passengers to evacuate.

Interface with fire alarm system

2.7.2.6 Emergency fire phones (a two-way voice communication system) shall be provided in lieu of manual call points in the station public areas such that a person needs not travel more than 90m to an emergency fire phone on any level to report a fire. The Passenger Service Centre (PSC), where provided, can be considered as a reporting station.

Emergency fire phones

2.7.2.7 For underground station, two-way emergency voice communication shall be provided between the Fire Command Centre (FCC) or in the absence of which, the main alarm panel (MAP) and the following:

Two-way communication

- (a) Every fire fighting lobby;
- (b) Fire pump room;
- (c) Fire lift;
- (d) Local manual control for smoke control equipment;
- (e) All lift motor rooms;
- (f) Passenger Service Centre (PSC); and
- (g) Air-handling control rooms if a manual on/off switch for the station's central air-conditioning system is not provided in the PSC.

2.7.2.8 Firemen intercom shall be provided for communication between the space where the tunnel dry mains breeching inlets are located at ground level and the buffer areas. The intercom unit at the buffer areas shall be located near the access stairs at the platform leading to the track level.

Firemen intercom



Locations of firemen intercom at platform level

2.7.2.9 Underground stations shall be provided with radio communication facilities capable of operating in the frequency band of 470 – 490 MHz range.

Radio communication

2.7.2.10 PA systems for stations with multiple transit lines shall be designed in accordance with Cl. 2.8.2.2.

Stations with multiple transit lines

2.7.2.11 In the PSC, emergency fire phones and hotline telephones which are required by the following clauses may be implemented as part of a central telephone console unit for voice communication:

- (a) Cl.2.7.2.6
- (b) Cl.2.7.3
- (c) Cl.2.8.2.1
- (d) Cl.2.8.3.2

Calls to the emergency fire phones and hotline telephones configured on the central telephone console shall not be blocked. The console shall not be inhibited from receiving new calls due to on-going calls.

Visual indication shall be provided to differentiate calls that are in-use, ringing or on-hold.

2.7.3 **HOTLINE TELEPHONE BETWEEN STATIONS AND OCC**

A hotline telephone (may be part of a central telephone console unit with button designated for hotline connection) shall be provided between each Passenger Service Centre (PSC), where provided and the OCC. Hotline telephones in stations with interchange-link shall be provided in accordance with Cl.2.8.3.2.

2.7.4 **SIGNAGE FOR FIREMEN**

Signage shall be provided on door to identify the room, space or the area that the door leads into. Signage shall also be provided at strategic locations in underground transit station to guide firemen entering the station from the firemen's staircase or firemen's staircases to every part of the station. The signage shall comply with SS 508.

Signage for firemen

2.7.5 **PLANS FOR FIREMEN**

2.7.5.1 Two paper sets of plans shall be kept next to the main alarm panel (MAP) in a dedicated plan box marked "BUILDING LAYOUT PLANS FOR FIREMEN" to help firemen to navigate in the station. The plans shall :

Plans for firemen

- (a) be minimum A3 size;

| | |
|--|--------------|
| <ul style="list-style-type: none"> (b) be without gridlines; (c) have spaces clearly annotated; (d) show the fire lift, firemen’s stair, smoke-stop lobbies, fire pump room, landing valves, two-way emergency voice communication handsets and firemen intercoms in red; and (e) be updated and in good condition at all times. | |
| <p>2.7.5.2 A locked glass-fronted plan box constructed of non-combustible material shall be provided and firmly mounted on wall. The key shall be kept in a glass-fronted box alongside the plan box or as part of the plan box. Signage complying with SS 508 shall be provided to read “IN CASE OF EMERGENCY, BREAK GLASS FOR KEYS”. A spare key shall be kept in the PSC.</p> | |
| <p>2.7.6 FIRE COMMAND CENTRE</p> | |
| <p>2.7.6.1 Where fire lift is provided in an underground station, a Fire Command Centre (FCC) shall be provided.</p> | |
| <p>2.7.6.2 A FCC shall be of adequate size to house all the terminals and supervisory / control equipment, etc. of the station's fire protection / detection systems and a free working space of at least 6 sq. m.</p> | Size |
| <p>2.7.6.3 A FCC shall be located adjacent to the fire lift lobby at the designated storey of the building i.e. the lobby of the building on the first storey or immediately adjacent thereto.</p> | Location |
| <p>2.7.6.4 The construction of enclosure, facilities and lighting of a FCC shall comply with the SS 546 Code of Practice for Emergency Voice Communication Systems in Buildings.</p> | Construction |
| <p>2.7.6.5 Mechanical ventilation, where required for the FCC, shall comply with</p> <ul style="list-style-type: none"> (a) An air-conditioning system or mechanical ventilation system, if required for the fire command centre, shall be independent of each other and any other system serving other parts of the station. (b) The mechanical ventilation rate shall be 6 air changes per hour. | |

- (c) Supply air shall be drawn directly from the external; its intake point shall be arranged with exhaust outlets to avoid re-circuiting of air/smoke back into the room.
- (d) Where the corresponding ducts run outside the fire command centre, they shall either be enclosed in a structure or constructed to give at least the same fire rating as the room which they serve or that of the room through which they traverse, whichever is higher.
- (e) No fire damper shall be fitted in either the supply or exhaust duct required under this clause.
- (f) Duct serving areas other than the fire command centre shall not pass through the room.

SECTION 2.8 INTEGRATION AND INTERFACE FOR STATIONS

ROOT OBJECTIVES

The primary intentions of this section pertaining to stations that integrate and interface with other transit lines, transit stations and non-transit occupancies, are encapsulated in the following statements:-

- R2.8.1 Occupants must be provided with adequate and appropriate means of escape before untenable conditions are reached during a fire emergency.
- R2.8.2 Provide means of alerting and communication for transit lines of integrated and/or interfaced stations, during a fire emergency.
- R2.8.3 Prevent spread of smoke and fire between transit and non-transit occupancies.

SUB-OBJECTIVES

The following criteria define the conditions necessary to fulfil the intentions of this section:-

- S2.8.1 Provisions of adequate and appropriate means of escape before untenable conditions are reached during a fire emergency, with considerations for:-
 - (i) accessibility; and
 - (ii) reliability; and
 - (iii) availability; and
 - (iv) free of obstruction.
- S2.8.2 Provisions of adequate and appropriate means of relaying information and instructions to the occupants during a fire emergency.
- S2.8.3 Provisions of adequate and appropriate means of alerting and communication for transit lines during a fire emergency.
- S2.8.4 Provisions for prevention of spread of fire to adjacent non-transit occupancies.
- S2.8.5 Provisions for prevention of migration of smoke from adjacent non-transit occupancies.

**SECTION 2.8
INTEGRATION AND INTERFACE FOR STATIONS**

2.8.1 GENERAL

This section stipulates the minimum fire safety provisions required for stations that integrate and interface with other transit lines, transit stations and non-transit occupancies.

2.8.2 STATIONS WITH MULTIPLE TRANSIT LINES

2.8.2.1 Hot-line telephone(s) shall be provided for two-way communication between the PSCs of these transit lines in the station, or in the absence of PSCs, the OCCs. The installation shall comply with SS 546.

2.8.2.2 Where individual public address (PA) systems are provided for the different transit lines within the station for their respective concourse and platform areas, these PA systems shall be designed such that announcements can be made by one of the transit lines over all the PA systems in the station simultaneously during an emergency.

2.8.2.3 One main fire alarm panel should be provided in accordance with Section 2.5.5. Where separate fire alarm systems for the different transit lines are desirable, separate fire alarm panels may be provided. These fire alarm panels shall be located in accordance with Section 2.5.5 and next to each other.

2.8.3 STATIONS WITH INTERCHANGE-LINK

2.8.3.1 Interchange-link shall not be included in the calculations of station exit capacity.

2.8.3.2 Hot-line telephone(s) shall be provided for two-way communication between the PSCs of these stations, or in the absence of PSCs, the OCCs. The installation shall comply with SS 546.

2.8.3.3 A summary fire alarm signal from each station shall be transmitted to the PSC(s) of the other station(s) connected by the interchange-link, or in the absence of PSC(s), the OCC(s). The transmission lines shall be electrically supervised. Upon receiving a summary fire alarm signal, an audible and visual alarm shall be activated at the PSC(s) or OCC(s). A silencing switch may be provided to silence the audible alarm but it shall not cancel the visual alarm.

General

Hot-line telephone

Public address system

Fire alarm panel

Interchange-link

Hot-line telephone

Fire alarm signal

2.8.4 STATIONS CONNECTED TO NON-TRANSIT OCCUPANCIES

2.8.4.1 Where an entrance of an underground station is integrated with a non-transit occupancy, the following shall be complied with:

- (a) The entrance shall comply with the relevant fire safety requirements in other sections of this Standard.
- (b) The entrance shall be fire separated from the non-transit occupancy with fire barriers having at least 2 hours fire resistance.
- (c) There shall be no unprotected openings at the non-transit occupancy area within 3m of the ventilation openings located in the external wall of the entrance.
- (d) Where fire-rated shutters are installed to provide the fire separation required in Cl.2.8.4.1(b), it shall be installed with localised smoke detector on both sides of the fire rated shutter. These fire-rated shutters shall be activated by:
 - the localised smoke detector/s on either side (ie. one side) of these fire shutters,
 - the adjacent building fire alarm zones in adjacent building.

Upon activation of the localized standalone smoke detector, an alarm signal shall be sent to the fire alarm panels of both the station & the adjacent building. Where motorised fire-rated shutters are provided, the fire-rated shutters after closing shall remain closed and be rendered inoperative until the alarm has been reset.

Note: This alarm signal is not used to trigger the building fire alarm but is intended to provide the status that the shutter is activated and is used as a means to reset the fire alarm panel to reopen the fire shutter after its activation. Therefore, the smoke detector located at the side of the shutter is not part of the building fire alarm.

- (e) Use of fire shutter not exceeding 6m in width is permitted.

Station entrance

Fire separation

Unprotected openings

Fire-rated shutters

2.8.4.2 Where a station has an underground link connected to a non-transit occupancy, the following shall be complied with:

(a) The link shall not be used as means of escape. The underground link shall be considered as part of the station and shall comply with the relevant fire safety requirements in other sections of this Standard.

Underground link

(b) The station shall be separated from the non-transit occupancy by fire-rated shutters having at least 2 hours fire resistance. The localised smoke detector shall be provided on both sides of the fire rated shutter. The fire-rated shutters shall be activated by:

Fire-rated shutters

- the localised smoke detector/s on either side (i.e. one side) of these fire shutters,

- the adjacent building fire alarm zones in adjacent building.

Upon activation of the localized standalone smoke detector, an alarm signal shall be sent to the fire alarm panels of both the station & the adjacent building. Where motorised fire-rated shutters are provided, the fire-rated shutters after closing by the activation of the smoke detector(s) shall remain closed and be rendered inoperative until the alarm has been reset.

Note: This alarm signal is not used to trigger the building fire alarm but is intended to provide the status that the shutter is activated and is used as a means to reset the fire alarm panel to reopen the fire shutter after its activation. Therefore, the smoke detector located at the side of the shutter is not part of the building fire alarm.

(c) Use of fire shutter not exceeding 6m in width is permitted.

2.8.4.3 Where a station has an elevated link/overhead-bridge connected to a non-transit occupancy, the following shall be complied with:

(a) The link shall not be used as means of escape. The elevated link shall be considered as part of the station and shall comply with the relevant fire safety requirements in other sections of this Standard.

Elevated link

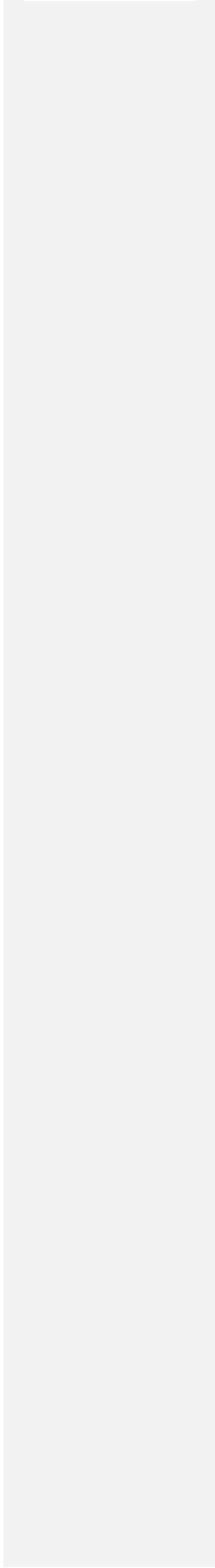
- 
- (b) Where the elevated link is enclosed and provided with mechanical ventilation or air-conditioning, means shall be provided to prevent smoke generated from a fire in the non-transit occupancies to migrate into the station.
- 

SECTION 2.9 UNDERGROUND OR ENCLOSED TRAINWAY

ROOT OBJECTIVES

The primary intentions of this section are encapsulated in the following statements:-

- R2.9.1 The trainways shall remain structurally stable to allow adequate time for occupants to evacuate and fire-fighters to conduct their fire-fighting and rescue operations.
- R2.9.2 Occupants must be able to evacuate to a safe place before untenable conditions are reached during a fire emergency.
- R2.9.3 Enable the safe escape of occupants from trainways during a fire emergency by having adequate and appropriate
 - (i) lighting; and
 - (ii) means of identifying exit routes.
- R2.9.4 Enable the continual use of fire-fighting facilities by providing adequate and appropriate lighting for the duration of the fire emergency.
- R2.9.5 Provide adequate and appropriate fire-fighting facilities for fire-fighters to conduct their fire-fighting operations in the trainways.
- R2.9.6 Provide effective means of communication for fire-fighters.
- R2.9.7 Maintain tenable conditions along the evacuation path by means of an effective emergency ventilation system.
- R2.9.8 Fire-fighters must be provided with means of access for fire-fighting and rescue operations.
- R2.9.9 Prevent re-circulation of smoke into the RTS system due to the effects of a fire in the trainways.

SUB-OBJECTIVES

The following criteria define the conditions necessary to fulfil the intentions of this section:-

- S2.9.1 Provision of elements of structure with appropriate fire resistance with respect to: -
- (i) fire severity; and
 - (ii) fire-fighting and rescue operations; and
 - (iii) occupants evacuation time; and
 - (iv) enclosure characteristics and configurations.
- S2.9.2 The construction and use of building materials shall be appropriate to the intended performance.
- S2.9.3 Provisions for measures to prevent premature structural collapse of any part of the trainways due to fire that would affect the safe egress of occupants, fire-fighting and rescue operations.
- S2.9.4 Provisions for adequate and appropriate exits along the trainways.
- S2.9.5 Provisions for accessibility of means of escape.
- S2.9.6 Provisions for adequate and appropriate means to enable occupants to
- (i) clearly identify exit locations; and
 - (ii) be guided to such exit locations
- during a fire emergency in the trainways.
- S2.9.7 Provisions for adequate lighting for safe evacuation of occupants.
- S2.9.8 Provisions for adequate fire-fighting facilities, including the necessary accessories for effective fire-fighting operation.
- S2.9.9 Provisions for means of communication for fire-fighting and rescue operations in the trainways.

S2.9.10 Provisions for ventilation for the life safety purposes such that, in the event of a fire, evacuation routes are maintained:

- (i) below thermal threshold for human tenability; and
- (ii) at visibility levels adequate for occupants evacuation; and
- (iii) below toxicity threshold for human tenability; and
- (iv) not impeding the movement and evacuation of occupants.

for the period of time required for evacuation.

S2.9.11 Provisions for ventilation to maintain safe conditions in the exits for occupants for the period of time required for escape.

S2.9.12 Provisions for reliability and availability of emergency ventilation systems.

S2.9.13 Provisions for appropriate access into trainways for fire-fighting and rescue operations.

S2.9.14 Provisions to prevent re-circulation of smoke into the RTS system due to the effects of a fire in the trainway, with consideration for:-

- (i) air intake openings; and
- (ii) station entrances; and
- (iii) station and / or trainway surface openings; and
- (iv) adjacent structures and property uses.

SECTION 2.9 UNDERGROUND OR ENCLOSED TRAINWAY

2.9.1 CONSTRUCTION MATERIALS

Construction materials

- 2.9.1.1 All underground or enclosed trainways including elements of structure of the trainways, cross passageways, doors and walk surface designated for evacuation of passengers shall be constructed of non-combustible materials.
- 2.9.1.2 The fire resistance of the elements of structure for the underground or enclosed trainway shall be not less than 4 hours.
- 2.9.1.3 Except as permitted in Cl.2.9.1.6, exposed PVC pipes, PVC conduits and fittings are not allowed in the underground or enclosed trainway.
- 2.9.1.4 The fire resistance of the elements of structure of remote vertical exit shafts and ventilation structures shall be not less than 2 hours. Test of fire resistance shall be in accordance with Cl.2.3.4.
- 2.9.1.5 Ancillary areas shall be separated from the trainway areas within underwater line sections (such as those under the sea, reservoir, river or canal) by a minimum of 3-hour fire-resistant construction. Ancillary areas shall be separated from the trainway areas within underground line sections by a minimum of 2-hour fire-resistant construction.
- 2.9.1.6 Coverboard or any protective material used to provide safety isolation from the contact traction power rail shall have a flame spread rating of not less than Class 1 as specified in Cl.2.3.13.3 when tested in accordance with BS 476: Part 7.

2.9.2 EXITS

Exits

- 2.9.2.1 Exits shall be provided from underground or enclosed trainways to a point of safety.
- 2.9.2.2 Exit staircases shall be provided throughout the underground or enclosed trainways and spaced so that the distance between exit staircases shall not be greater than 760m. The staircase shall be enclosed and shall lead directly to the outdoors or to a safe refuge area. The minimum clear width of the staircase shall be 1 m. Handrails shall be provided in accordance with Cl.2.2.5.6(f). The staircase shall be ventilated in accordance with Section 2.6.

2.9.2.3 Where underground or enclosed trainways are divided by a minimum of 2-hour fire-rated walls or where trainways are in twin bores, such an arrangement shall be deemed to afford adequate protection for the passengers via cross passageways between the trainways and, therefore, shall be permitted to be utilised in lieu of exit staircases to the surface. In this situation, the following shall apply:

- (a) The distance between a cross passageway and an exit staircase or the platform public area shall not be more than 500m (*Diagram 2.9.2.3(a)*).
- (b) Cross passageways shall not be further than 250m apart.
- (c) Opening in cross passageway with a minimum clear width of 1m shall be protected with a fire door assembly having a fire resistance of not less than 2 hours with a self-closing device.
- (d) A non-contaminated environment shall be provided in that portion of the trainway that is not involved in an emergency and that is being used for evacuation.
- (e) A ventilation system for the contaminated trainway shall be designed to control smoke in the vicinity of passengers.
- (f) A suitable method shall be provided for evacuating passengers in the uncontaminated trainway, for protecting passengers from on-coming traffic, and for evacuating the passengers to a nearby station or other exit.
- (g) Where cross-over is provided that breaks the fire separation between enclosed trainways, the following conditions shall be complied with:
 - (i) The design of the emergency ventilation system shall also meet the requirements of Cl.2.9.6.5(a) for the scenario where train fire occurs at the cross-over.
 - (ii) Distance between the cross passageways at upstream and downstream of the cross-over shall be not more than 500m apart.

- (iii) Distance between the cross-over and the nearest cross passageway shall be not less than 125m and not more than 250m.

See Diagram 2.9.2.3(g)

2.9.2.4 Doors to an exit shall open in the direction of exit travel except in the case of cross passageway closures. Doors to the exit access in the trainways shall be provided with a self-closing device but no locking device shall be provided. The force required to open the doors fully when applied to the latch sided shall be as low as possible, not exceeding 220N. In addition, door and hardware shall be adequate to withstand the positive and negative pressures created by passing trains.

Doors

2.9.2.5 An effective emergency egress pathway of minimum 800mm width shall be provided. In areas with cross passageways, unobstructed access shall be provided to the cross passageways.

Emergency egress pathway

2.9.2.6 The walking surfaces of the emergency egress pathway shall have a non-slip design.

2.9.2.7 Where the trainway concreted track bed serves as emergency egress pathway, it shall be nominally level and free of obstructions. Where signalling equipment is located along the emergency egress pathway, ramp and platform shall be provided. The edges of the ramp and platform shall be painted with bright yellow paint to enhance its visibility.

2.9.3 EXIT SIGNS AND EMERGENCY LIGHTING

2.9.3.1 Exit facilities shall be suitably identified and maintained to allow for their intended use.

Exit signs and emergency lighting

2.9.3.2 Exit signs at exit staircases shall comply with the requirements as specified for stations in Cl.2.7.1.7, whereas, non-maintained illuminated exit signs at cross passageways shall be designed to be remotely controlled to support the evacuation strategy.

2.9.3.3 Signage shall be provided to assist emergency evacuation of passengers. The signs should be reflective or illuminated.

2.9.3.4 Emergency lighting shall be provided to underground or enclosed trainways exceeding 15m in length. The illumination level at walking surfaces shall not be less than 2.7 lux.

2.9.3.5 The emergency lighting shall be connected to an emergency power supply capable of maintaining the minimum illumination level for at least 2 hours.

2.9.3.6 Fire resistant cables of minimum 2-hour rating shall be used.

2.9.4 FIRE PROTECTION

Fire Protection

2.9.4.1 Underground or enclosed trainways shall be provided with dry mains. The dry main system and its associated water supply, control and testing requirements shall be installed in accordance with SS 574, except as herein modified:

- (a) Dry main system shall be provided in accordance with *Diagram 2.9.4.1(a)* for the following areas:
 - i) Each underground trainway located between two stations;
 - ii) Each underground or enclosed trainway between a station and the trainway portal; and
 - iii) Each underground or enclosed reception or test track.
- (b) For over-run trainway, the dry main system can be served with only one breeching inlet at the station end.
- (c) The nominal bore of the dry main shall not be less than 150mm.
- (d) The dry mains in the trainways need not be fire-rated.
- (e) Landing valves shall be located at not less than 2m and not more than 3m from exit staircases and cross passageways and shall be spaced at intervals not exceeding 60m along the trainway.
- (f) The first landing valve of the dry main after the breeching inlet shall be located not exceeding 3m from the interface of the station box and the trainway. For the case of C1.2.9.4.1(a)(ii), the first landing valve after the breeching inlet shall be located not more than 3m from the portal.
- (g) Where gaskets are used in pipe joints for dry mains serving different trainways but located in common TV vent shaft and TVF fan room, the gaskets shall be suitable for use in an ambient atmosphere of 250°C.

| | | |
|---------|--|------------------------------|
| 2.9.4.2 | The breaching inlets shall be located within 18m from the fire engine accessway and be visible from the fire engine accessway. Breaching inlets shall be appropriately numbered and labelled as shown in <i>Diagram 2.9.4.2</i> . | Breaching inlets |
| 2.9.4.3 | <p>Two standby hoses shall be provided at each of the following locations:</p> <ul style="list-style-type: none"> (a) Buffer area within 3m from the stair leading to the trainways (see <i>Diagram 2.9.4.3(a)</i>); (b) Mid tunnel exit staircase; and (c) Underground or enclosed trainway portal (see <i>Diagram 2.9.4.3(c)</i>). <p>Standby hoses shall be provided in accordance with APPENDIX F with the exception of Cl. F2.1.</p> | Standby hoses |
| 2.9.4.4 | Automatic fire detection systems shall be provided at designated locations in underground or enclosed trainways where trains are stabled during non-revenue hours. The guidance for selection of detectors is described in SS CP 10. The use of line type heat detectors is permissible. | |
| 2.9.5 | COMMUNICATION | Communication |
| 2.9.5.1 | Underground or enclosed trainways shall be provided with radio communication facilities capable of operating in the frequency band of 470 - 490 MHz range. | |
| 2.9.5.2 | Fire resistant cables complying with SS 299 shall be used for communication system equipment specified in this standard, except for the leaky co-axial (LCX) cables which are required to be fire retardant. | |
| 2.9.6 | EMERGENCY VENTILATION SYSTEM | |
| 2.9.6.1 | A mechanical emergency ventilation shall be provided in underground or enclosed trainways exceeding 300m. | Emergency Ventilation System |
| 2.9.6.2 | A mechanical emergency ventilation system is not required for underground or enclosed trainways not exceeding 60m in length. | |

- 2.9.6.3 An engineering analysis is required for underground or enclosed trainways exceeding 60m but not exceeding 300m to determine if a mechanical emergency ventilation is required. The analysis shall take into consideration all the factors that affect fire safety. A report of the analysis shall be submitted. If the engineering analysis is not carried out, then a mechanical ventilation system shall be provided.
- 2.9.6.4 The emergency ventilation system shall make provisions for the protection of people from fire and smoke during a fire in the underground or enclosed trainways and shall be designed to maintain the required air flow rates for a minimum of 2 hours.
- 2.9.6.5 The emergency ventilation system shall :
- (a) Provide a tenable environment along the paths of egress in the incident and non-incident trainways; and
 - (b) Be able to achieve the critical velocity; and
 - (c) Be capable of reaching full operational mode within 120 seconds or less.
 - (d) Address the maximum number of trains that could be between ventilation shafts during an emergency.
- 2.9.6.6 The design shall encompass the following:
- (a) The heat release rate from a vehicle and any other combustible materials (if permitted) in the trainways that could contribute to the fire load at the incident site, subject to the approval of the relevant authority.
 - (b) The rate of fire growth.
 - (c) Station and trainway geometries.
 - (d) Fans, shafts and devices for directing air.
 - (e) Predetermined procedures for initiating quick response from the OCC during fire.
- 2.9.6.7 The emergency ventilation system fans shall be capable of satisfying the emergency ventilation requirements in either the supply or exhaust mode. Emergency ventilation fan motors shall be designed to achieve their full operating speed in 30 seconds or less from a stopped position when started across the line and in 60 seconds or less for variable speed motors.

- 2.9.6.8 Emergency ventilation fans, their motors and all related components exposed to the exhaust airflow shall be capable of operating in an atmosphere of 250° C for a minimum of 2 hours. The emergency ventilation fans shall be provided such that in the event one of the fans in the operating system is not operational, the other fan(s) shall be capable of maintaining the system design.
- 2.9.6.9 Local fan motor starters and related operating control devices shall be located as far away from the direct air stream of the fans. Thermal overload protective devices shall not be used on motor control of fans used for emergency ventilation.
- 2.9.6.10 Fans not designed to function during fire shall shut down automatically upon activation of an emergency ventilation system unless it can be proven that the emergency air flow is not jeopardised or conflicted with.
- 2.9.6.11 Cables used for wiring the fans and the associated controls shall comply with Cl.2.1.4.
- 2.9.6.12 Operation of the emergency ventilation system shall be initiated from the Operation Control Centre (OCC). Local controls, located in the Passenger Service Centre (PSC) of the station, shall be provided and be allowed to control the emergency ventilation system only when the authority is delegated from the OCC to the station PSC.
- 2.9.6.13 Devices of the emergency ventilation system such as dampers, louvres, silencers, etc., shall be capable of withstanding the repetitive and additive piston effect of moving trains and emergency air velocities. Such devices shall be of non-combustible, fire resistant materials and be protected, to the greatest extent practical, against fire near the incident area.
- 2.9.6.14 Vent shafts that penetrate the surface and that are used for intake and discharge in fire emergencies shall be designed to prevent recirculation of smoke into the station and trainway through air intake openings, station entrances and other surface openings.

2.9.7 ACCESS TO UNDERGROUND OR ENCLOSED TRAINWAY PORTAL

A minimum 1-m wide access stair from the ground level to the underground or enclosed trainway portal shall be provided. A gate of minimum 1m width shall be placed as close as possible to the portal to permit easy access to underground or enclosed trainway.

Emergency ventilation system control/operation

Access to underground or enclosed trainway portal

2.9.8 **MOTORISED TROLLEY**

- 2.9.8.1 Motorised trolley shall be provided at each of the following location:
- (a) Station platform level
 - (b) Mid tunnel exit staircase more than 380m from a station
 - (c) Trainway portal
- 2.9.8.2 Motorised trolley shall be constructed of non-combustible material and firmly hanged on wall. Accessories (ie. batteries, battery chargers, ignition key, handle and controller) shall be housed in steel cabinet. Signage complying with SS 508 shall be provided to read “ACCESSORIES FOR MOTORISED TROLLEY”. The front part of the cabinet must allow the status of batteries to be easily monitored. The cabinet shall be locked. The key shall be kept in a glass-fronted glazed box alongside the cabinet or as part of the cabinet. Signage complying with SS 508 shall be provided to read “IN CASE OF EMERGENCY, BREAK GLASS FOR KEYS”. A spare key shall be kept in the PSC.
- 2.9.8.3 Motorised trolley provided at station platform level, mid-tunnel exit staircase and trainway portal shall have access to all trainways. Otherwise, separate motorised trolley shall be provided for each trainway.
- 2.9.8.4 Motorised trolley provided at station platform level shall be within a travel distance of not more than 20m to the end platform steps leading to the trackway.
- 2.9.8.5 Motorised trolley located in mid-tunnel exit staircase shall not impede the means of escape.
- 2.9.8.6 Valve regulated lead acid (sealed type) batteries shall be used for the motorised trolley. Two sets of batteries (one spare) shall be provided for each trolley.
- 2.9.8.7 Ventilation shall be provided to comply with Clause 2.6.2.2(g).

Diagram 2.9.2.3(a) - Location of first cross passageway in underground trainways

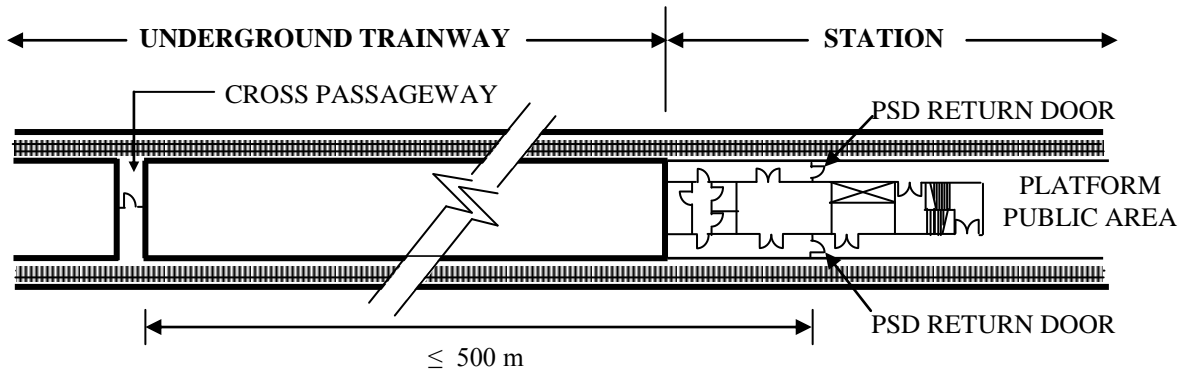

Diagram 2.9.2.3 (g) – Cross-over between enclosed trainways

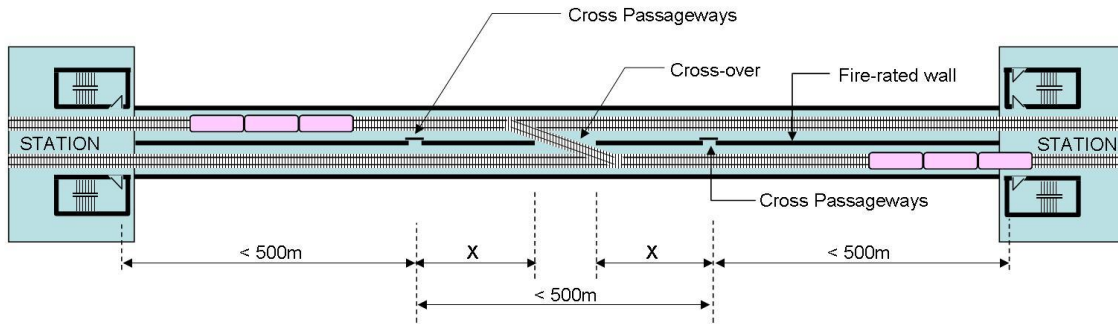

Diagram 2.9.2.3(g)

125m < X < 250m

Diagram 2.9.4.1(a) - Dry main system in underground or enclosed trainway

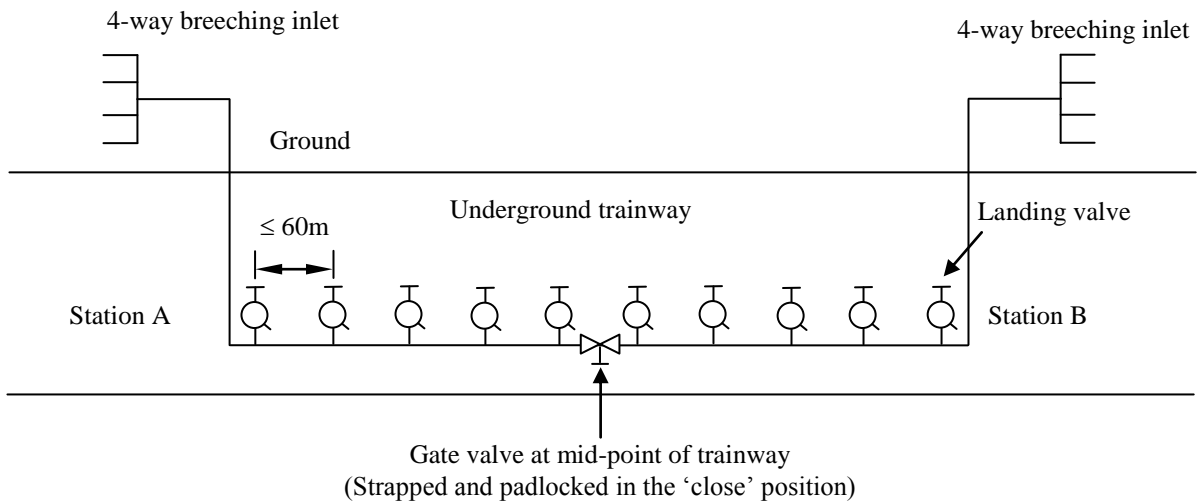

Diagram 2.9.4.2 - Numbering and labelling of breaching inlets for underground or enclosed trainway dry rising mains
(See also Cl. 2.5.3.7)

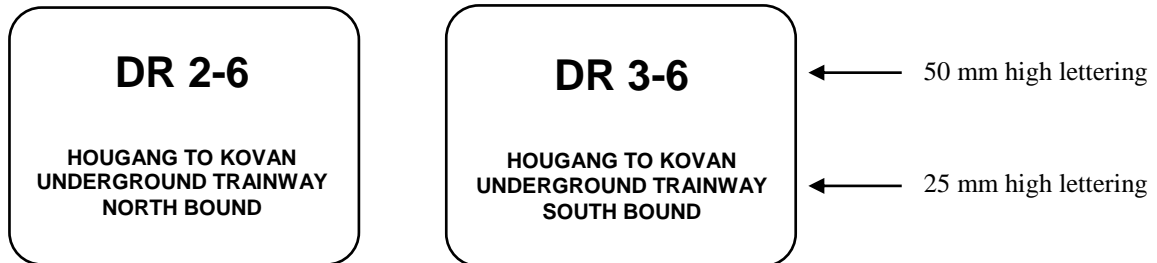

Diagram 2.9.4.3(a) - Location of standby hoses outside platform public area

2 standby hoses for underground trainway dry riser system
(Same provision at the other end of the station)

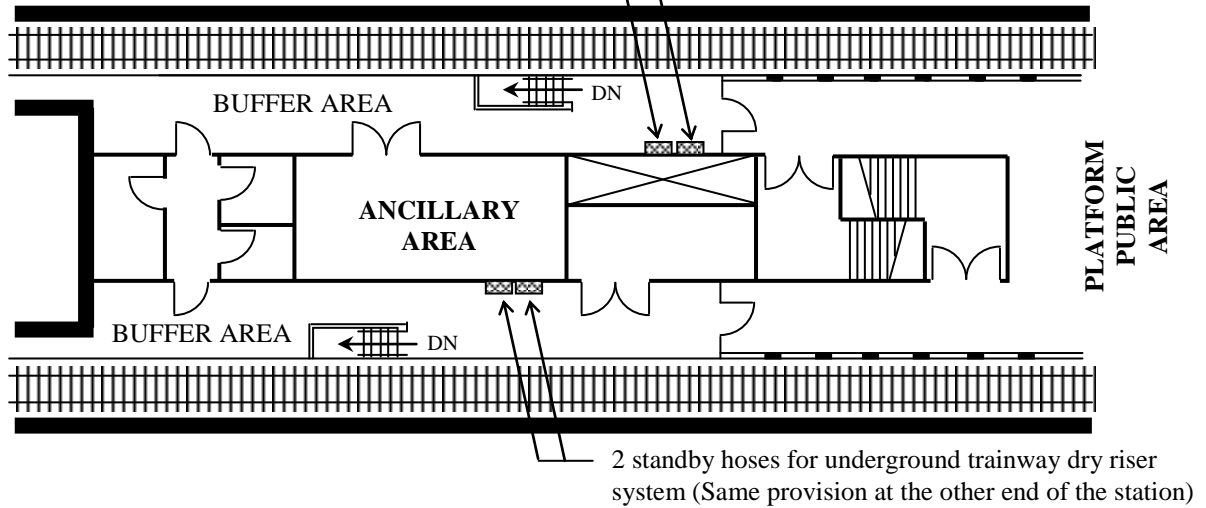
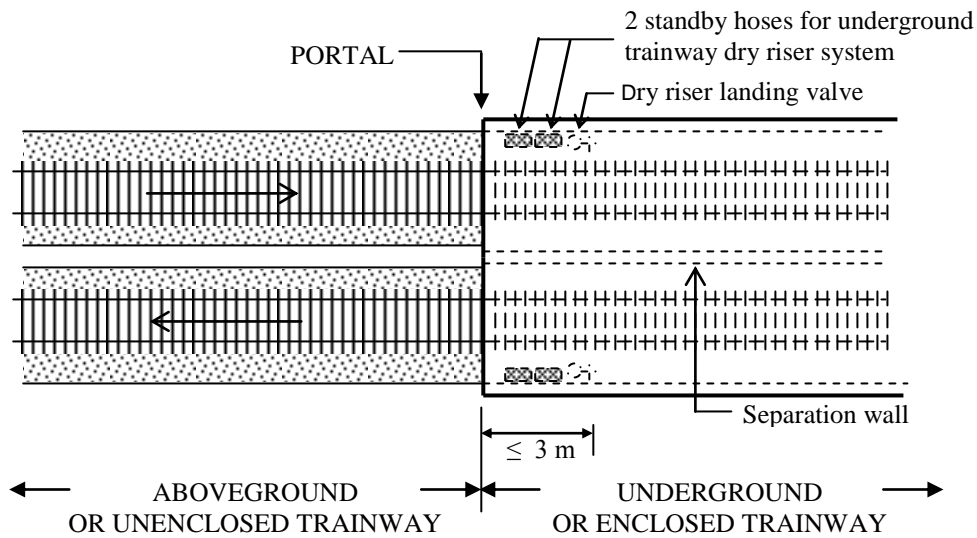

Diagram 2.9.4.3(c) - Location of standby hoses at underground or enclosed trainway portal



SECTION 2.10 ABOVEGROUND TRAINWAYS

ROOT OBJECTIVES

The primary intentions of this section are encapsulated in the following statements:-

- R2.10.1 The trainways shall remain structurally stable to allow adequate time for occupants to evacuate and fire-fighters to conduct their fire-fighting and rescue operations.
- R2.10.2 Avoid the spread of fire from and to adjacent buildings.
- R2.10.3 Provide emergency access to enable effective mounting of fire-fighting and rescue operations.
- R2.10.4 Occupants must be able to evacuate to a safe place.

SUB-OBJECTIVES

The following criteria define the conditions necessary to fulfil the intentions of this section:-

- S2.10.1 Provisions of elements of structure with appropriate fire resistance with respect to:-
 - (i) fire severity; and
 - (ii) fire-fighting and rescue operations; and
 - (iii) occupant evacuation time; and
 - (iv) height of the trainway; and
 - (v) different levels of fire risk.
- S2.10.2 The use of materials should be appropriate to the intended performance.
- S2.10.3 Provisions for prevention of spread of fire from and to adjacent buildings.
- S2.10.4 Provisions for emergency access for effective manoeuvring of fire-fighting appliances.
- S2.10.5 Provisions for emergency access with proper identification for effective fire-fighting and rescue operations.
- S2.10.6 Provisions for safe movement of occupants along the trainways to a safe place.

SECTION 2.10 ABOVEGROUND TRAINWAYS

2.10.1 CONSTRUCTION MATERIALS

- 2.10.1.1 Aboveground trainways shall be constructed of non-combustible materials.
- 2.10.1.2 The elements of structure for aboveground trainways shall have a fire resistance of not less than 2 hours.
- 2.10.1.3 Test of fire resistance shall be in accordance with Cl.2.3.4.
- 2.10.1.4 Coverboard or any protective material used to provide safety isolation from the contact traction power rail shall have a flame spread rating of not less than Class 1 as specified in Cl.2.3.13.3 when tested in accordance with BS 476: Part 7.

2.10.2 SETBACK DISTANCE

- 2.10.2.1 Setback distance between trainway structure and adjacent building
 - (a) The setback distance between the proposed trainway structure and the adjacent building shall comply with the distance stipulated in Appendix D based on the extent of unprotected openings in the external wall of the adjacent building, using the outermost edge of the proposed trainway structure as the relevant boundary, or at least 6m clear of the outermost edge of the proposed trainway structure, whichever is greater (*Diagram 2.10.2.1(a)*).
 - (b) For proposed trainway located outside the development boundary of a private development, the distance between the adjacent building(s) and the outermost edge of the proposed trainway shall be at least 6m (*Diagram 2.10.2.1(b)*).
- 2.10.2.2 The setback distance shall be measured from the edge of trainways to the external wall of the adjacent buildings.
- 2.10.2.3 The height of the enclosing rectangle used in the calculations shall be measured up to the height of the trainways.

Construction materials

Setback distance



2.10.3 **EMERGENCY ACCESS**

Emergency access

- 2.10.3.1 Emergency access to the trainways shall be provided.
- 2.10.3.2 Access to trainway shall be from the station or via the firemen’s mobile ladder or equipment from roadway adjacent to the trainways. If no adjacent or crossing roadway exist, access roads at a maximum 800m intervals shall be required. The design of the access road shall be similar to that of the fire engine accessway stipulated in Section 2.4.
- 2.10.3.3 Where security fences are used to secure an area along the trainways, access gates, minimum 1 m wide, shall be provided. Information that clearly identifies the route and location of each gate shall be provided on the gates or adjacent thereto.

2.10.4 **EGRESS FOR PASSENGERS**

Egress for passengers

- 2.10.4.1 The Rapid Transit System shall incorporate means for passengers to evacuate a train at any point along the trainways and reach a point of safety. System egress points shall be illuminated.
- 2.10.4.2 An emergency pathway of minimum 800mm width shall be provided along the trainways. Unobstructed access, such as steps or ramp, shall be provided at cross-over trackway
- 2.10.4.3 Where the trainway concreted track bed serves as emergency egress pathway, it shall be nominally level and free of obstructions. Where signalling equipment is located along the emergency egress pathway, ramp and platform shall be provided. The edges of the ramp and platform shall be painted with bright yellow paint to enhance its visibility.

Diagram 2.10.2.1(a) - Separation distance

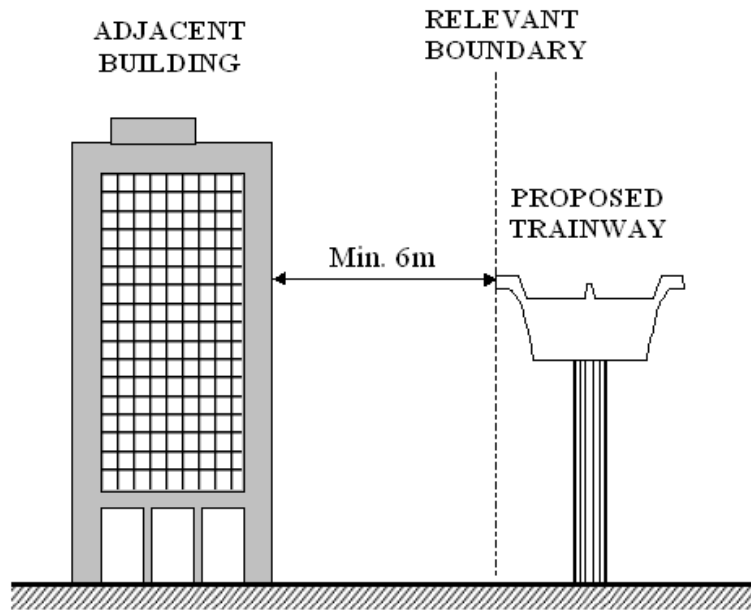
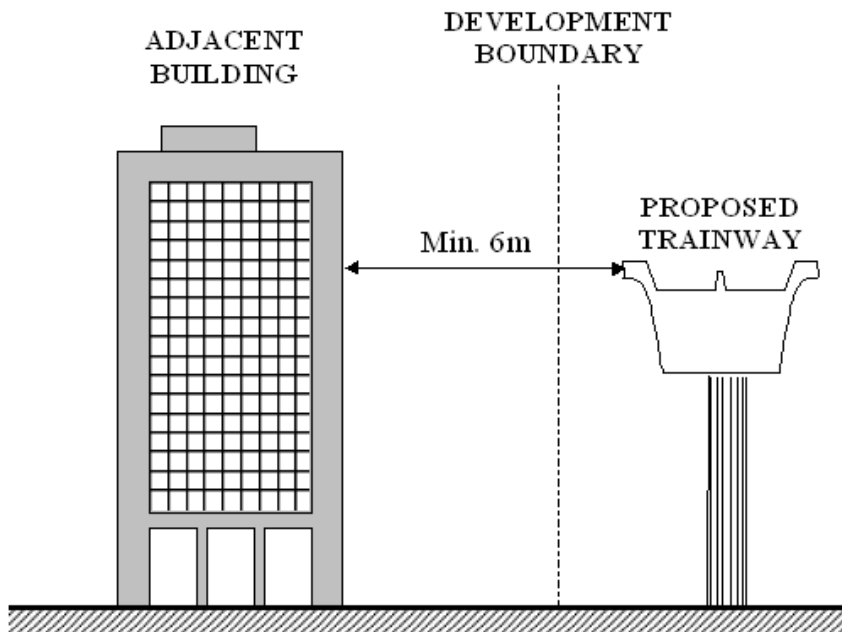

Diagram 2.10.2.1(b) - Separation distance – proposed trainway outside development boundary





PART III - RTS DEPOT AND RELATED FACILITY BUILDINGS

**SECTION 3.1
DEPOT**

The performance-based provisions of the Fire Code shall be applicable to the depot.

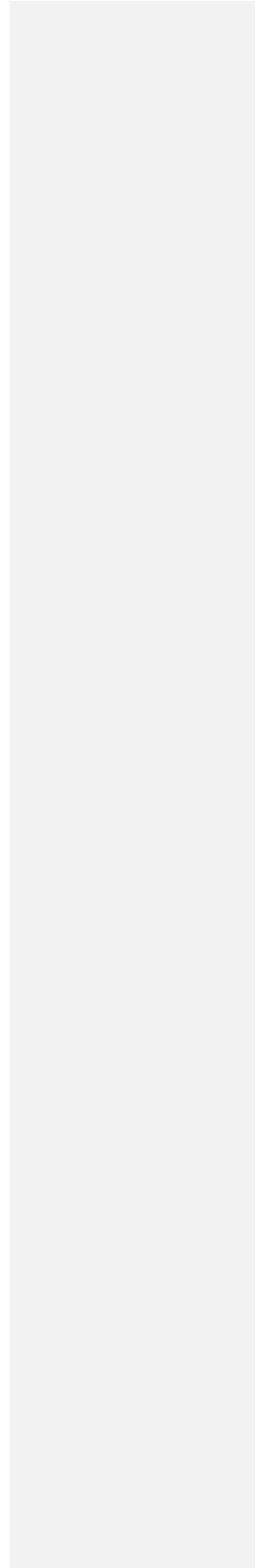

SECTION 3.1 DEPOT

3.1.1 GENERAL

Requirements stipulated in the previous sections of this Standard for transit stations and trainways are not applicable to the depot. The depot shall comply fully with the requirements of the Code of Practice for Fire Precautions in Buildings except as herein modified:

- (a) Areas with traction power shall not be covered/protected by hose reels. A 6-m wide zone on plan, enveloping the unenclosed area with traction power (shown shaded in the diagram below) need not be fully covered/protected by hose reels;

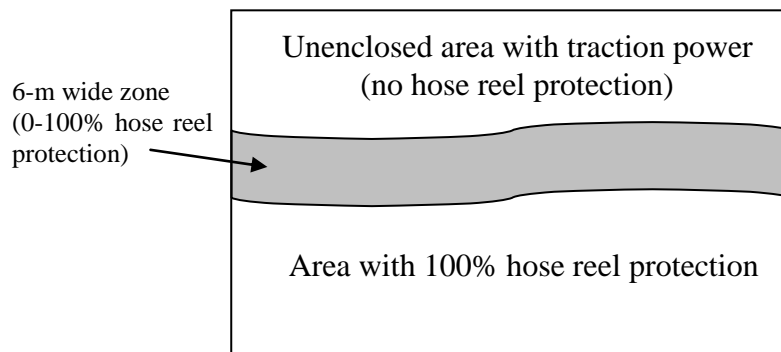

- (b) Hose reels and sprinklers shall not be provided in stores (e.g. thermit and volatile stores) containing materials that react explosively with water;
- (c) The depot shall be considered as a factory (purpose group VI);
- (d) Elements of structure forming the fire separation between track areas/sidings of the depot and non-transit occupancies shall have at least 4-hour fire resistance (see *Diagram 3.1.1(d)*);
- (e) The fire resistance of elements of structure around underground track areas/sidings shall not be less than 4 hours;
- (f) The occupant loads for the track areas and sidings shall be determined based on the expected number of people occupying the areas;

Hose reels and areas with traction power

Fire separation from non-transit occupancies

Occupant loads

- (g) The maximum travel distance for the track areas, sidings and workshop areas for the trains shall be as follows:

| | <u>Sprinklered</u> | <u>Unsprinklered</u> |
|----------|--------------------|----------------------|
| One-way | 30m | 15m |
| Two-way | 120m | 90m |
| Dead-end | 15m | 15m |

Note: The maximum two-way travel distance for the siding shall not exceed 150m if exits are provided at both ends of the siding and that the siding is sprinklered.

- (h) Fire safety report shall be prepared in accordance with chapter 9 of the Fire Code and submitted.
- (i) Battery rooms shall be ventilated to maintain the average hydrogen concentration by volume in the room below 2%.
- (j) In lieu of smoke detectors, linear heat detectors of the optic fibre type can be used to activate the engineered smoke control systems in non-public areas.
- (k) The automatic fire alarm system shall be connected to the OCC.

Travel distances for track areas, sidings and train workshop areas

Fire safety report

3.1.2 **TWO-WAY EMERGENCY VOICE COMMUNICATION SYSTEM**

For depot with basement storey(s), two-way emergency voice communication system complying with SS 546 shall be provided to the basement storey(s), except for requirements on locations of remote handsets as modified herein.

The master handset of the two-way emergency voice communication system shall be located near the main alarm panel. Remote handsets shall be provided at the following locations, if present at the basement storey(s):

- (a) Fire-fighting lobbies
- (b) Fire pump room
- (c) Rooms housing smoke control equipment
- (d) Lift motor rooms
- (e) Fire Lifts

Two-way
emergency
voice
communica-
tion system

3.1.3 **RADIO COMMUNICATION**

Basement storey(s) of depot shall be provided with radio communication facilities capable of operating in the frequency band of 470 – 490 MHz range.

Radio
communica-
tion

3.1.4 **DESIGN FIRE SIZE AND PERIMETER**

Where required to be provided with engineered smoke control system, the design train fire size and perimeter shall be substantiated, subject to the approval of the relevant authority.

Design fire
size and
perimeter

Diagram 3.1.1(d) - Element of Structure forming fire separation between depot and non-transit occupancies shall have 4 hour fire resistance rating

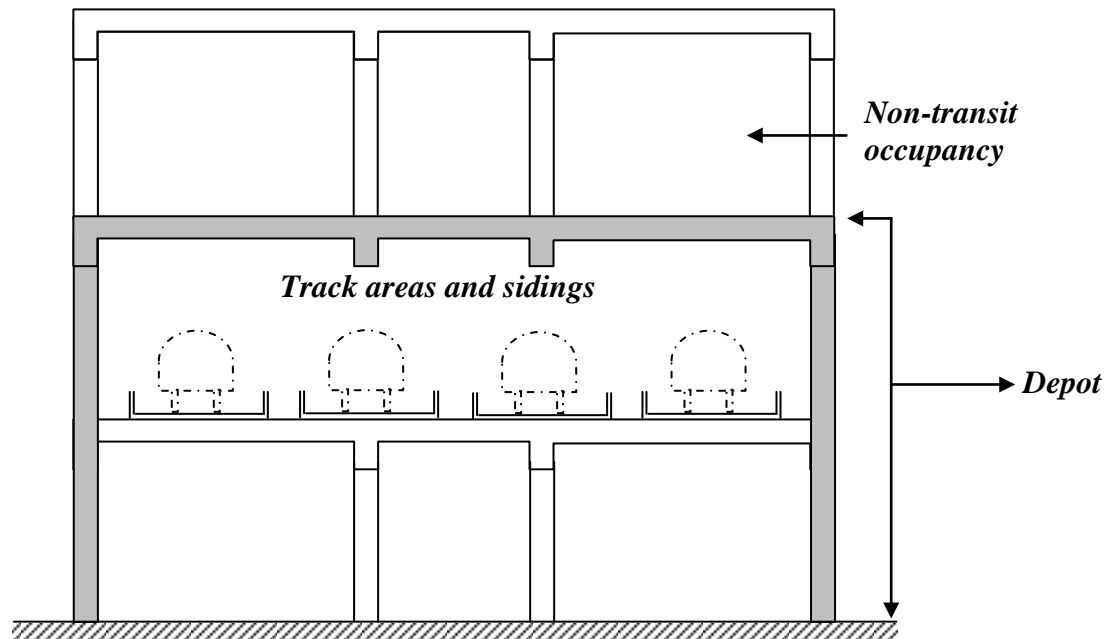

 Element of structure (having at least 4-hour fire resistance forming the fire separation

SECTION 3.2 OPERATION CONTROL CENTRE AND RAPID TRNASIT SYSTEM FACILITY BUILDINGS

The performance-based provisions of the Fire Code shall be applicable to the RTS facility buildings. Additional performance-based provisions for the Operation Control Centre (OCC) and RTS facility buildings are stipulated below.

ROOT OBJECTIVES

The primary intentions of this section are encapsulated in the following statements:-

For OCC

- R3.2.1 Maintain functionality and accessibility of the OCC during fire in the adjacent area.
- R3.2.2 Provide appropriate means to alert SCDF in the event of a fire in the transit line.

For RTS Facility Buildings

- R3.2.3 Prevent fire spread and damage to aboveground trainways.
- R3.2.4 Provide appropriate means to detect fire and alert the OCC.

SUB-OBJECTIVES

The following criteria define the conditions necessary to fulfil the intentions of this section:-

For OCC

- S3.2.1 Provisions for prevention of spread of fire to the OCC.
- S3.2.2 Provisions for accessibility of the OCC during fire in the adjacent area.
- S3.2.3 Provisions for reliable source of power supply for continual operation of equipment critical to fire safety and train operation.
- S3.2.4 Provisions for adequate and appropriate ventilation to the OCC during fire in the adjacent area.

For RTS Facility Buildings

- S3.2.5 Provisions for prevention of spread of fire to aboveground trainways.
- S3.2.6 Provisions for appropriate and adequate systems to detect fire and alert the OCC.

**SECTION 3.2
OPERATION CONTROL CENTRE AND
RAPID TRANSIT SYSTEM FACILITY BUILDINGS**

3.2.1 OPERATION CONTROL CENTRE (OCC)

3.2.1.1 The OCC shall have a fire separation of not less than 2 hours from other areas. It shall be provided with dedicated access/exit from/to the external via enclosures having a fire resistance of not less than 2 hours.

Note: The protected enclosure is not necessary if the access/exit is direct from/to the external.

3.2.1.2 Equipment of OCC essential for the operation of trains and the tunnel ventilation system shall be provided with secondary power supply.

3.2.1.3 The OCC shall have the same ventilation requirements as a Fire Command Centre (FCC).

3.2.1.4 A hotline shall be provided between the OCC and SCDF's Fire Control Room.

3.2.1.5 The above requirements of OCC shall apply to the standby OCC, where provided.

3.2.2 RAPID TRANSIT SYSTEM (RTS) FACILITY BUILDINGS

3.2.2.1 Requirements stipulated in the previous sections of this Standard for transit stations and trainways are not applicable to the RTS facility buildings. RTS facility buildings e.g. on-line electric sub-station, relay building and other electrical and mechanical installations etc. shall comply fully with the Code of Practice for Fire Precautions in Buildings.

3.2.2.2 For RTS facility buildings under the aboveground trainways, the following requirements shall also be complied with:

(a) Building within 6m of the outer edges of the aboveground trainway shall be at least 2-hr compartmented; and

(b) Automatic fire alarm system shall be provided in accordance with SS CP10. The fire alarm system shall be connected to the OCC.

Fire separation

Power supply

Ventilation

Hotline

Standby OCC

RTS facility buildings under aboveground trainways

PART IV - ELECTRICAL SYSTEM FOR RAPID TRANSIT SYSTEMS

SECTION 4.1 ELECTRICAL SYSTEM FOR RAPID TRANSIT SYSTEMS

ROOT OBJECTIVES

The primary intentions of this section are encapsulated in the following statements:-

- R4.1 Provide reliable source of power supply for continuity of services required for life safety, fire-fighting and rescue operations during a fire emergency.

SUB-OBJECTIVES

There is no sub-objective for this section.

**SECTION 4.1
ELECTRICAL SYSTEM
FOR RAPID TRANSIT SYSTEMS**

4.1.1 SCOPE

Scope

4.1.1.1 The scope of this part of the Standard covers the requirements for electrical power supply in the rapid transit systems.

4.1.2 INSTALLATION

Installation

4.1.2.1 The installation, control and distribution of wiring of electrical equipment in buildings shall be in accordance with SS CP 5 Code of Practice for Wiring of Electrical Equipment of Buildings and SS 551 Code of Practice for Earthing. However, the cables used in the stations and trainways shall comply with the requirements stipulated in Cl.2.1.4 of this Standard.

4.1.3 PRIMARY AND SECONDARY SUPPLIES

Primary and secondary supplies

4.1.3.1 Where any of the following installations are required by this Standard or other Codes/Regulations, its primary and secondary source of power supplies shall comply with the corresponding Code of Practice stated therein:

- a) Where electrical passenger or goods lift or fire lift is required, SS 550;
- b) Where electrical fire Alarm is required, SS CP 10;
- c) Where exit and emergency lighting is required, SS 575;
- d) Where an emergency voice communication system is required, SS 546;
- e) Where a wet rising main is required, SS 574;
- f) Where an automatic sprinkler system is required, SS CP 52; and
- g) Where mechanical ventilation system is required, SS 553.

| | | |
|---------|--|------------------------------|
| 4.1.3.2 | Notwithstanding the above, dual feeder power supply are deemed to have been provided with primary and secondary source of power supplies. For the purposes of this Standard, the primary feeder (primary supply) shall be the normal power supply while the secondary feeder (secondary supply) shall be the emergency power supply. (See diagram 4.1.3.2). | Dual electric feeder |
| 4.1.3.3 | <p>The following systems shall be provided with a secondary source of supply:</p> <ul style="list-style-type: none"> (a) Mechanical ventilation system for room housing fire pumps; (b) Mechanical ventilation system for smoke-stop / fire fighting lobbies; (c) Underplatform exhaust where required to operate during a fire emergency; (d) Emergency ventilation system of underground or enclosed trainway; (e) Emergency lighting of underground or enclosed trainway; and (f) Exit signs of underground or enclosed trainway. | Secondary source of supply |
| 4.1.3.4 | Where emergency generators are provided as a secondary source of supply, they shall comply with SS 535 Code of Practice for Installation, Operation, Maintenance, Performance and Constructional Requirements of Mains Failure Standby Generating Systems. | Emergency generators |
| 4.1.3.5 | Uninterruptible power supply (UPS) consisting of centralised batteries can be considered as a secondary source of power supply. | Uninterruptible power supply |

Diagram.4.1.3.2 - Block diagram of typical RTS station dual feeder LV power supply Scheme

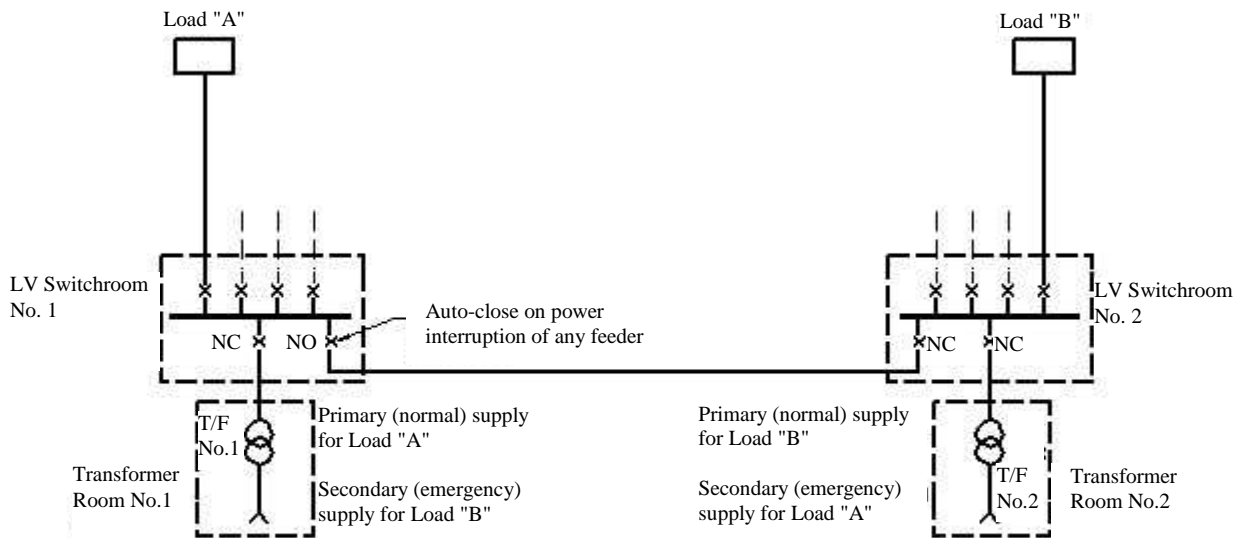

LEGEND
 NO - Normally Open
 NC - Normally Close

Block diagram of typical RTS station dual feeder HT power supply Scheme

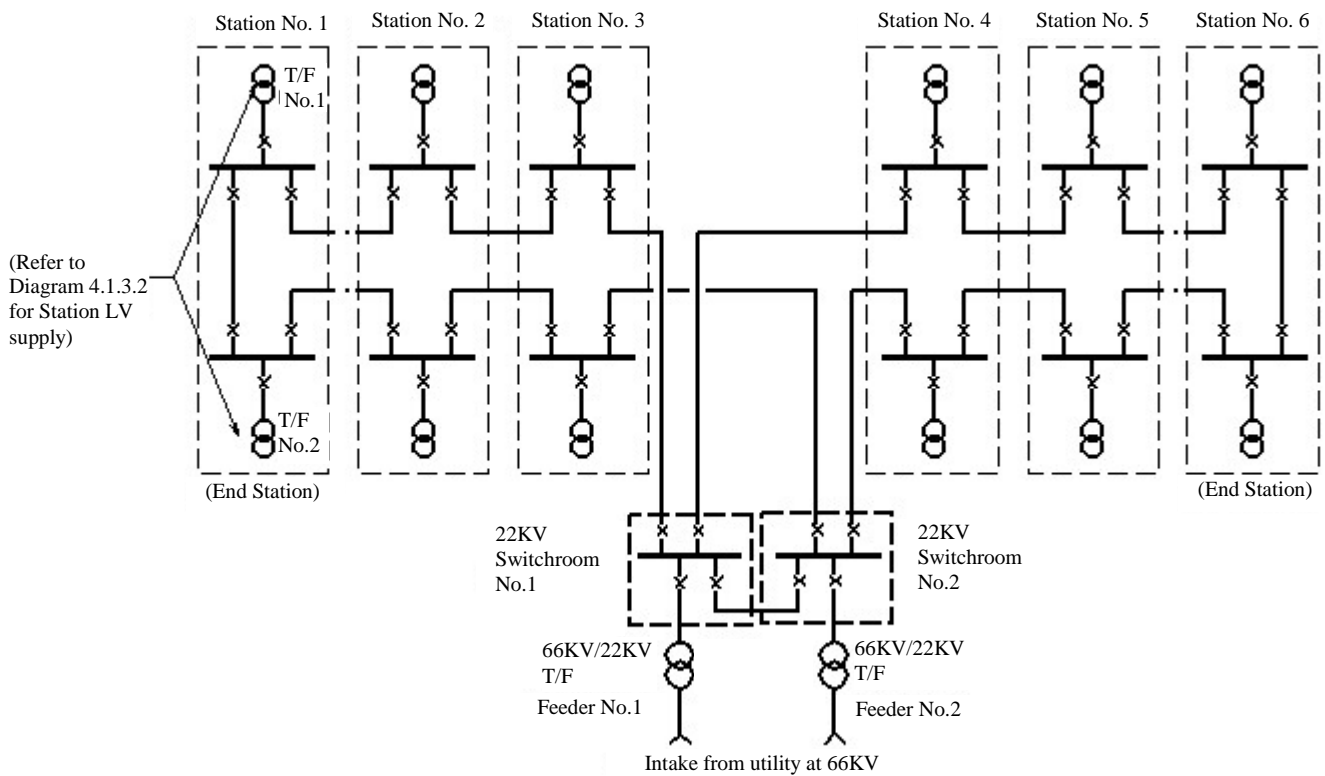

APPENDIX A OCCUPANT LOAD CALCULATIONS

This appendix is not a part of the requirement of the Standard for Fire Safety in Rapid Transit Systems but is included for informational purposes only

A.1 GENERAL

- A.1.1 Transit station dimensions are determined as a function of the length of trains employed in a transit system. Thus the areas of station platforms in light density outlying stations will be equal to those of heavy density downtown central business district transit stations. Consequently, occupancy loads in rapid transit Stations, based on the emergency condition requiring evacuation of that station to a point of safety, are a function of the train-carrying capacities rather than platform areas categorized as a “place of assembly”.
- A.1.2 The occupant load is the basis on which most new or expanding transit systems are designed. The methodology for determining passenger use of transit systems varies considerably between specific systems, but a study usually will permit a determination of “peak hour loads”. Most systems also will determine "peak hour reversal" from morning to afternoon to reflect commuter loads.
- A.1.3 The basis for calculating occupant loads should be the a.m. and p.m. peak hour patronage figures projected for design of new transit systems. The platform occupant load for each platform shall be the greater of the a.m. or the p.m. peak period loads calculated.
- A.1.4 For new transit systems the projected peak hour passenger figures can be converted to the peak minute loads by dividing by 60 and multiplying by 1.3. The 1.3 is the system surge factor and can be varied for a particular system if sufficient data is available for verification. Both link loads and entraining loads are converted in this manner.
- A.1.5 The peak period station occupant load for each platform is composed of two parts: the entraining load awaiting a train and the calculated train load of trains simultaneously entering the station on all tracks during the peak period.
- A.1.6 The entraining load as used for exit calculations is calculated from peak minute entraining loads by multiplying by the headway and multiplying by two to allowed for one missed headway.

Occupant load

Entraining
load

- A.1.7 Where trains arrive at a platform from only one direction, the “calculated train load” as used for exit calculations is calculated from the peak minute link load by multiplying by two times the headway to allow for one missed headway. The maximum for the “calculated train load” should be the train crush load.
- A.1.8 Where trains arrive at a platform from more than one direction, the entraining load and calculated train load for the peak direction are computed as described above. In the off-peak direction, the entraining load and calculated train load are computed from the peak minute entraining load and the peak minute link load respectively, by multiplying the headway.

A.2 SINGLE SERVICE PLATFORMS

- A.2.1 Tables A and B illustrate the methodology for calculating the occupant load at a single service side platform and centre platform respectively. The calculations are described in A.2.2 and A.2.3 below.
- A.2.2 For a single service side platform, as shown in Table A,
- (a) The calculated train load is determined for each of the side platform for both the a.m. and the p.m. peak periods according to the formula:
[Peak hour link load ÷ 60 x surge factor x train headway x 2], and
 - (b) The maximum for the calculated train load shall be the train crush load, and
 - (c) The entraining load is determined for each of the side platform for both the a.m. and the p.m. peak periods according to the formula:
[Peak hour entraining figure ÷ 60 x surge factor x train headway x 2], and
 - (d) The calculated platform occupant load for each of the side platform for both the a.m. and the p.m. peak periods is the sum of calculated train load and entraining load, and
 - (e) The calculated platform occupant loads for each of the side platform for both the a.m. and the p.m. peak periods are compared to determine the maximum occupant load at each platform.

Single service platform occupant load calculation

A.2.3 For a single service centre platform, as shown in Table B,

- (a) The calculated train load for the peak direction is determined for both the a.m. and the p.m. peak periods according to the formula:
[Peak hour link load \div 60 x surge factor x train headway x 2], and
- (b) The calculated train load for the off-peak direction is determined for both the a.m. and the p.m. peak periods according to the formula:
[Peak hour link load \div 60 x surge factor x train headway], and
- (c) The maximum for the calculated train load shall be the train crush load, and
- (d) The entraining load for the peak direction is determined for both the a.m. and the p.m. peak periods according to the formula:
[Peak hour entraining figure \div 60 x surge factor x train headway x 2], and
- (e) The entraining load for the off-peak direction is determined for both the a.m. and the p.m. peak periods according to the formula:
[Peak hour Entraining figure \div 60 x surge factor x train headway], and
- (f) The calculated platform occupant load for both the a.m. and the p.m. peak periods is the sum of calculated train loads and entraining loads, and
- (g) The calculated platform occupant loads for a.m. and p.m. peak, and for northbound or southbound as peak direction are compared to determine the maximum platform occupant load.

A.3 MULTI-SERVICE PLATFORMS

A.3.1 Tables C and D illustrate the methodology for calculating the occupant load at a multi-service side platform and centre platform respectively. The calculations are described in A.3.2 and A.3.3 below.

Multi service platform occupant load calculation

A.3.2 For a multi-service side platform, as shown in Table C,

- (a) The calculated train load is determined for each of the side platform for both the a.m. and the p.m. peak periods according to the formula:
[Peak hour link load \div 60 x surge factor x train headway x 2], and
- (b) The maximum for the calculated train load shall be the train crush load, and
- (c) The entraining load for the train service that arrived at the platform is determined for each of the side platform for both the a.m. and the p.m. peak periods according to the formula:
[Peak hour entraining figure \div 60 x surge factor x train headway x 2], and
- (d) The entraining load for the other train service is determined for each of the side platform for both the a.m. and the p.m. peak periods according to the formula:
[Peak hour entraining figure \div 60 x surge factor x (train headway x 2 - time lag)], and
- (e) The transfer load between services awaiting for the train service arriving at the platform is determined for each of the side platform for both the a.m. and the p.m. peak periods according to the formula (see example on the pattern of transfer loads on platform shown in Figure 1):
[Peak hour transfer figure \div 60 x surge factor x train headway], and
- (f) The calculated platform occupant load for each of the side platform for both the a.m. and the p.m. peak periods is the sum of calculated train load, entraining loads and transfer load, and
- (g) Calculated platform occupant loads are determined for scenarios based on each train service arrived at each of the side platform, and
- (h) The calculated platform occupant loads for each of the side platform for both the a.m. and the p.m. peak periods are compared to determine the maximum occupant load at each platform.

A.3.3 For a multi-service centre platform, as shown in Table D-1 to Table D-5,

- (a) The calculated train load for the peak direction is determined for both the a.m. and the p.m. peak periods according to the formula:
[Peak hour Link Load \div 60 x surge factor x train headway x 2], and
- (b) The calculated train load for the off-peak direction is determined for both the a.m. and the p.m. peak periods according to the formula:
[Peak hour Link Load \div 60 x surge factor x train headway], and
- (c) The maximum for the calculated train load shall be the train crush load, and
- (d) The entraining load for the train service that arrived at the platform for the peak direction is determined for both the a.m. and the p.m. peak periods according to the formula:
[Peak hour Entraining figure \div 60 x surge factor x train headway x 2], and
- (e) The entraining load for the other train service for the peak direction is determined for both the a.m. and the p.m. peak periods according to the formula:
[Peak hour entraining figure \div 60 x surge factor x (train headway x 2 - time lag)], and
- (f) The entraining load for the train service that arrived at the platform for the off-peak direction is determined for both the a.m. and the p.m. peak periods according to the formula:
[Peak hour Entraining figure \div 60 x surge factor x train headway], and
- (g) The entraining load for the other train service for the off-peak direction is determined for both the a.m. and the p.m. peak periods according to the formula:
[Peak hour entraining figure \div 60 x surge factor x (train headway - time lag)], and
- (h) The transfer loads between services are determined for both the a.m. and the p.m. peak periods according to the sequence of train services. (See example on the pattern of transfer loads on platform in Figure 2.)

- (i) The calculated platform occupant load is the sum of calculated train loads, entraining loads and transfer loads, and
- (j) Calculated platform occupant loads are determined for scenarios based on northbound or southbound as peak direction, and various combinations of train services arrived at the northbound and southbound directions, and
- (k) The calculated platform occupant loads for a.m. and p.m. peak, and for northbound or southbound as peak direction, as well as for various combinations of train services arrived at the platform are compared to determine the maximum platform occupant load.

A.4 **MULTI-LEVEL PLATFORM STATION**

- A.4.1 At multi-level platform station, for the purpose of determining required exit capacity at each platform, maximum occupant load for each platform shall be calculated separately as per A.2 and A.3.
- A.4.2 For determining required egress capacity at points where egress routes converge, the platform occupant load from non-incident platforms needs to consider only the normal entraining and detraining loads.

Multi-level
platform
station
occupant load
calculation

APPENDIX A, TABLE A : SINGLE SERVICE SIDE PLATFORM

| | | | | | | |
|----|---|--|-------------------------|-------------------------|-------------------------|-------------------------|
| 1 | A | | | | | G |
| 2 | | | | | | |
| 3 | | | | | | |
| 4 | | | | | | |
| 5 | | | | | | |
| 6 | | Surge Factor | | | | |
| 7 | | Train Headway (minutes) | | | | |
| 8 | | Train Crush Load (Persons) | | | | |
| 9 | | | | | | |
| 10 | | | | | | |
| 11 | | AM | | PM | | |
| 12 | | Northbound | Southbound | Northbound | Southbound | |
| 13 | | Peak Hour Passenger Figures | | | | |
| 14 | | Link Load | | | | |
| 15 | | Entraining | | | | |
| 16 | | Calculated Loads for Exit Calculations | | | | |
| 17 | | Calculated Train Load | =MIN(C8,C14/60*C6*C7*2) | =MIN(C8,D14/60*C6*C7*2) | =MIN(C8,E14/60*C6*C7*2) | =MIN(C8,F14/60*C6*C7*2) |
| 18 | | Calculated Entraining Load | =C15/60*C6*C7*2 | =D15/60*C6*C7*2 | =E15/60*C6*C7*2 | =F15/60*C6*C7*2 |
| 19 | | Occupant Loads for Exit Calculations | | | | |
| 20 | | Platform Occupant Load | =C17+C18 | =D17+D18 | =E17+E18 | =F17+F18 |
| 21 | | | | | | |
| 22 | | | | | | |
| 23 | | <p><u>Northbound Platform</u></p> <p>Platform Occupant Load = MAX (C20, E20)</p> | | | | |
| 24 | | <p>→ Train →</p> | | | | |
| 25 | | <p>← Train ←</p> | | | | |
| 26 | | <p><u>Southbound Platform</u></p> <p>Platform Occupant Load = MAX (D20, F20)</p> | | | | |
| 27 | | | | | | |
| 28 | | | | | | |
| 29 | | | | | | |
| 30 | | | | | | |
| 31 | | | | | | |
| 32 | | | | | | |
| 33 | | | | | | |
| 34 | | | | | | |
| 35 | | | | | | |
| 36 | | | | | | |
| 37 | | | | | | |

APPENDIX A, TABLE B : SINGLE SERVICE CENTRE PLATFORM

| | A | B | C | D | E | F | G |
|----|---|---|---|---|---|---|---|
| 1 | | | | | | | |
| 2 | | | | | | | |
| 3 | | | | | | | |
| 4 | | | | | | | |
| 5 | | | | | | | |
| 6 | | | | | | | |
| 7 | | | | | | | |
| 8 | | | | | | | |
| 9 | | | | | | | |
| 10 | | | | | | | |
| 11 | | | | | | | |
| 12 | | | | | | | |
| 13 | | | | | | | |
| 14 | | | | | | | |
| 15 | | | | | | | |
| 16 | | | | | | | |
| 17 | | | | | | | |
| 18 | | | | | | | |
| 19 | | | | | | | |
| 20 | | | | | | | |
| 21 | | | | | | | |
| 22 | | | | | | | |
| 23 | | | | | | | |
| 24 | | | | | | | |
| 25 | | | | | | | |
| 32 | | | | | | | |
| 33 | | | | | | | |
| 34 | | | | | | | |
| 35 | | | | | | | |
| 36 | | | | | | | |
| 37 | | | | | | | |
| 38 | | | | | | | |
| 39 | | | | | | | |
| 40 | | | | | | | |
| 41 | | | | | | | |
| 42 | | | | | | | |

| | |
|----------------------------|--|
| Surge Factor | |
| Train Headway (minutes) | |
| Train Crush Load (Persons) | |

| | AM | | PM | |
|--|-------------------------|-------------------------|-------------------------|-------------------------|
| | Northbound | Southbound | Northbound | Southbound |
| Peak Hour Passenger Figures | | | | |
| Link Load | | | | |
| Entraining | | | | |
| Calculated Loads for Exit Calculations using Northbound as Peak Direction | | | | |
| Calculated Train Load | =MIN(C8,C14/60*C6*C7*2) | =MIN(C8,D14/60*C6*C7) | =MIN(C8,E14/60*C6*C7*2) | =MIN(C8,F14/60*C6*C7) |
| Calculated Entraining Load | =C15/60*C6*C7*2 | =D15/60*C6*C7 | =E15/60*C6*C7*2 | =F15/60*C6*C7 |
| Platform Occupant Load | =C17+C18+D17+D18 | | =E17+E18+F17+F18 | |
| Calculated Loads for Exit Calculations using Southbound as Peak Direction | | | | |
| Calculated Train Load | =MIN(C8,C14/60*C6*C7) | =MIN(C8,D14/60*C6*C7*2) | =MIN(C8,E14/60*C6*C7) | =MIN(C8,F14/60*C6*C7*2) |
| Calculated Entraining Load | =C15/60*C6*C7 | =D15/60*C6*C7*2 | =E15/60*C6*C7 | =F15/60*C6*C7*2 |
| Platform Occupant Load | =C21+C22+D21+D22 | | =E21+E22+F21+F22 | |

Diagram illustrating the platform layout and load calculation. The platform is shown with two train tracks: Northbound (top) and Southbound (bottom). The Platform Occupant Load is calculated as the maximum of C19, E19, C23, and E23.

APPENDIX A, TABLE C : MULTI-SERVICE SIDE PLATFORM

| A | B | C | D | E | F | G |
|----|---|---------------------------|---------------------------|---------------------------|---------------------------|---|
| 1 | | | | | | |
| 2 | Surge Factor | | | | | |
| 3 | Crush Train Load (Persons) | | | | | |
| 4 | Train Headway (min.) | | | | | |
| 5 | | | | | | |
| 6 | NORTHBOUND PLATFORM | | | | | |
| 7 | a. m. | | | p. m. | | |
| 8 | Service A | Service B | Service A | Service B | | |
| 9 | Link Load (Persons/Hour) | | | | | |
| 10 | Entraining (Persons/Hour) | | | | | |
| 11 | Transfer (Persons/Hour) | | | | | |
| 12 | From Service A | | | | | |
| 13 | From Service B | | | | | |
| 14 | Arrival Time-lag (minutes) | | | | | |
| 15 | After Service A | | | | | |
| 16 | After Service B | | | | | |
| 17 | Service A at Platform | | | | | |
| 18 | Calculated Train Load | =MIN((C9/60*C2*C4*2),C3) | | =MIN((E9/60*C2*C4*2),C3) | | |
| 19 | Entraining Load | =C10/60*C2*C4*2 | =D10/60*C2*(C4*2-D15) | =E10/60*C2*C4*2 | =F10/60*C2*(C4*2-F15) | |
| 20 | Transfer Load | =C13/60*C2*C4 | | =E13/60*C2*C4 | | |
| 21 | Platform Occupant Load | =C18+C19+D19+C20 | | =E18+E19+F19+E20 | | |
| 22 | Service B at Platform | | | | | |
| 23 | Calculated Train Load | | =MIN((D9/60*C2*C4*2),C3) | | =MIN((F9/60*C2*C4*2),C3) | |
| 24 | Entraining Load | =C10/60*C2*(C4*2-C16) | =D10/60*C2*C4*2 | =E10/60*C2*(C4*2-E16) | =F10/60*C2*C4*2 | |
| 25 | Transfer Load | | =D12/60*C2*C4 | | =F12/60*C2*C4 | |
| 26 | Platform Occupant Load | =D23+C24+D24+D25 | | =F23+E24+F24+F25 | | |
| 27 | | | | | | |
| 28 | SOUTHBOUND PLATFORM | | | | | |
| 29 | a. m. | | | p. m. | | |
| 30 | Service A | Service B | Service A | Service B | | |
| 31 | Link Load (Persons/Hour) | | | | | |
| 32 | Entraining (Persons/Hour) | | | | | |
| 33 | Transfer (Persons/Hour) | | | | | |
| 34 | From Service A | | | | | |
| 35 | From Service B | | | | | |
| 36 | Arrival Time-lag (minutes) | | | | | |
| 37 | After Service A | | | | | |
| 38 | After Service B | | | | | |
| 39 | Service A at Platform | | | | | |
| 40 | Calculated Train Load | =MIN((C31/60*C2*C4*2),C3) | | =MIN((E31/60*C2*C4*2),C3) | | |
| 41 | Entraining Load | =C32/60*C2*C4*2 | =D32/60*C2*(C4*2-D37) | =E32/60*C2*C4*2 | =F32/60*C2*(C4*2-F37) | |
| 42 | Transfer Load | =C35/60*C2*C4 | | =E35/60*C2*C4 | | |
| 43 | Platform Occupant Load | =C40+C41+D41+C42 | | =E40+E41+F41+E42 | | |
| 44 | Service B at Platform | | | | | |
| 45 | Calculated Train Load | | =MIN((D31/60*C2*C4*2),C3) | | =MIN((F31/60*C2*C4*2),C3) | |
| 46 | Entraining Load | =C32/60*C2*(C4*2-C38) | =D32/60*C2*C4*2 | =E32/60*C2*(C4*2-E38) | =F32/60*C2*C4*2 | |
| 47 | Transfer Load | | =D34/60*C2*C4 | | =F34/60*C2*C4 | |
| 48 | Platform Occupant Load | =D45+C46+D46+D47 | | =F45+E46+F46+F47 | | |
| 49 | | | | | | |
| 50 | | | | | | |
| 51 | | | | | | |
| 52 | <div style="border: 1px solid black; padding: 5px; margin-bottom: 10px;"> <p style="text-align: center;">Northbound Platform</p> <p style="text-align: center;">Platform Occupant Load =MAX(C21,E21,C26,E26)</p> </div> | | | | | |
| 53 | <div style="display: flex; justify-content: center; align-items: center; gap: 20px;"> <div style="border: 1px solid black; width: 150px; height: 20px; background-color: #cccccc;"></div> <div style="font-size: 24px;">→</div> <div style="border: 1px solid black; width: 300px; height: 20px; background-color: #cccccc; text-align: center;">TRAIN</div> <div style="font-size: 24px;">→</div> </div> | | | | | |
| 54 | <div style="display: flex; justify-content: center; align-items: center; gap: 20px;"> <div style="border: 1px solid black; width: 150px; height: 20px; background-color: #cccccc;"></div> <div style="font-size: 24px;">←</div> <div style="border: 1px solid black; width: 300px; height: 20px; background-color: #cccccc; text-align: center;">TRAIN</div> <div style="font-size: 24px;">←</div> </div> | | | | | |
| 55 | <div style="border: 1px solid black; padding: 5px; margin-top: 10px;"> <p style="text-align: center;">Southbound Platform</p> <p style="text-align: center;">Platform Occupant Load =MAX(C43,E43,C48,E48)</p> </div> | | | | | |
| 56 | | | | | | |
| 57 | | | | | | |
| 58 | | | | | | |
| 59 | | | | | | |
| 60 | | | | | | |
| 61 | | | | | | |
| 62 | | | | | | |
| 63 | | | | | | |
| 64 | | | | | | |
| 65 | | | | | | |
| 66 | | | | | | |
| 67 | | | | | | |

APPENDIX A, TABLE D-1 : MULTI-SERVICE CENTRE PLATFORM

| | A | B | C | D | E | F | G | |
|----|---|----------------------------|-----------------|-----------------|------------------|-------------------|---|--|
| 1 | | | | | | | | |
| 2 | | Surge Factor | | | | | | |
| 3 | | Crush Train Load (Persons) | | | | | | |
| 4 | | Train Headway (min.) | | | | | | |
| 5 | | | | | | | | |
| 6 | | | | | | | | |
| 7 | | | a. m. | | | | | |
| 8 | | | NORTH BOUND | | SOUTH BOUND | | | |
| 9 | | | Service A | Service B | Service A | Service B | | |
| 10 | | Link Load (Persons/Hour) | | | | | | |
| 11 | | Entraining (Persons/Hour) | | | | | | |
| 12 | | Transfer (Persons/Hour) | | | | | | |
| 13 | | From Service A (NB) To | | | | | | |
| 14 | | From Service A (SB) To | | | | | | |
| 15 | | From Service B (NB) To | | | | | | |
| 16 | | From Service B (SB) To | | | | | | |
| 17 | | Arrival Time-lag (minutes) | | | | | | |
| 18 | | After Service A | | | | | | |
| 19 | | After Service B | | | | | | |
| 20 | | | | | | | | |
| 21 | | | | | | | | |
| 22 | | | p. m. | | | | | |
| 23 | | | NORTH BOUND | | SOUTH BOUND | | | |
| 24 | | | Service A | Service B | Service A | Service B | | |
| 25 | | Link Load (Persons/Hour) | | | | | | |
| 26 | | Entraining (Persons/Hour) | | | | | | |
| 27 | | Transfer (Persons/Hour) | | | | | | |
| 28 | | From Service A (NB) To | | | | | | |
| 29 | | From Service A (SB) To | | | | | | |
| 30 | | From Service B (NB) To | | | | | | |
| 31 | | From Service B (SB) To | | | | | | |
| 32 | | Arrival Time-lag (minutes) | | | | | | |
| 33 | | After Service A | | | | | | |
| 34 | | After Service B | | | | | | |
| 35 | | | | | | | | |
| 36 | | | | | | | | |
| 37 | | | | | | | | |
| 38 | | | Scenarios 1 - 4 | Scenarios 5 - 8 | Scenarios 9 - 12 | Scenarios 13 - 16 | | |
| 39 | | Platform Occupant Load | =Table D-2!D62 | =Table D-3!D62 | =Table D-4!D62 | =Table D-5!D62 | | |
| 40 | | | | | | | | |
| 41 | | | | | | | | |
| 42 | | | | | | | | |
| 43 | | | | | | | | |
| 44 | | | | | | | | |
| 45 | | | | | | | | |
| 46 | | | | | | | | |
| 47 | | | | | | | | |
| 48 | | | | | | | | |
| 49 | | | | | | | | |
| 50 | | | | | | | | |
| 51 | | | | | | | | |
| 52 | | | | | | | | |
| 53 | | | | | | | | |
| 54 | | | | | | | | |
| 55 | | | | | | | | |

Platform Occupant Load =MAX(C39,D39,E39,F39)

APPENDIX A, TABLE D-2 : MULTI-SERVICE CENTRE PLATFORM

| | A | B | C | D | E | F | G | |
|----|---|-----------------------------------|--------------------------------------|---------------------------|------------------------|------------------------------|------------------|--|
| 1 | | | | | | | | |
| 2 | | Surge Factor | C2 | | | | | |
| 3 | | Crush Train Load (Persons) | C3 | | | | | |
| 4 | | Train Headway (min.) | C4 | | | | | |
| 5 | | | | | | | | |
| 6 | | | | a. m. | | | | |
| 7 | | | | NORTH BOUND (PEAK) | | SOUTHBOUND (OFF-PEAK) | | |
| 8 | | | | Service A | Service B | Service A | Service B | |
| 9 | | Link Load (Persons/Hour) | C9 | D9 | E9 | F9 | | |
| 10 | | Entraining (Persons/Hour) | C10 | D10 | E10 | F10 | | |
| 11 | | Transfer (Persons/Hour) | | | | | | |
| 12 | | From Service A (NB) To | | D12 | | F12 | | |
| 13 | | From Service A (SB) To | | D13 | | F13 | | |
| 14 | | From Service B (NB) To | C14 | | E14 | | | |
| 15 | | From Service B (SB) To | C15 | | E15 | | | |
| 16 | | Arrival Time-lag (minutes) | | | | | | |
| 17 | | After Service A | | D17 | | F17 | | |
| 18 | | After Service B | C18 | | E18 | | | |
| 19 | | Scenario 1: | | | | | | |
| 20 | | Northbound | | | | | | |
| 21 | | - Service A at Platform | | | | | | |
| 22 | | Southbound | | | | | | |
| 23 | | - Service A at Platform | | | | | | |
| 24 | | Calculated Train Load | =MIN((C9/60*C2*C4*2),C3) | | =MIN((E9/60*C2*C4),C3) | | | |
| 25 | | Entraining Load | =C10/60*C2*C4*2 | =D10/60*C2*(C4*2-D17) | =E10/60*C2*C4 | =F10/60*C2*(C4-F17) | | |
| 26 | | Transfer Load | =(C14+C15*2)/60*C2*C4 | =D13/60*C2*C4 | =E15/60*C2*C4 | | | |
| 27 | | Platform Occupant Load | =C24+C25+C26+D25+D26+E24+E25+E26+F25 | | | | | |
| 28 | | Scenario 2: | | | | | | |
| 29 | | Northbound | | | | | | |
| 30 | | - Service A at Platform | | | | | | |
| 31 | | Southbound | | | | | | |
| 32 | | - Service B at Platform | | | | | | |
| 33 | | Calculated Train Load | =C24 | | | =MIN((F9/60*C2*C4),C3) | | |
| 34 | | Entraining Load | =C25 | =D25 | =E10/60*C10*(C4-E18) | =F10/60*C10*C4 | | |
| 35 | | Transfer Load | =(C14+C15*2)/60*C2*C4 | =(D13*2)/60*C2*C4 | | =F13/60*C2*C4 | | |
| 36 | | Platform Occupant Load | =C33+C34+C35+D34+D35+E34+F33+F34+F35 | | | | | |
| 37 | | Scenario 3: | | | | | | |
| 38 | | Northbound | | | | | | |
| 39 | | - Service B at Platform | | | | | | |
| 40 | | Southbound | | | | | | |
| 41 | | - Service A at Platform | | | | | | |
| 42 | | Calculated Train Load | | =MIN((D9/60*C2*C4*2),C3) | =E24 | | | |
| 43 | | Entraining Load | =C10/60*C2*(C4*2-C18) | =D10/60*C2*C4*2 | =E25 | =F25 | | |
| 44 | | Transfer Load | =(C15*2)/60*C2*C4 | =(D12+D13*2)/60*C2*C4 | =E26 | | | |
| 45 | | Platform Occupant Load | =C43+C44+D42+D43+D44+E42+E43+E44+F43 | | | | | |
| 46 | | Scenario 4: | | | | | | |
| 47 | | Northbound | | | | | | |
| 48 | | - Service B at Platform | | | | | | |
| 49 | | Southbound | | | | | | |
| 50 | | - Service B at Platform | | | | | | |
| 51 | | Calculated Train Load | | =D42 | | =F33 | | |
| 52 | | Entraining Load | =C43 | =D43 | =E34 | =F34 | | |
| 53 | | Transfer Load | =C15/60*C2*C4 | =(D12+D13*2)/60*C2*C4 | | =F35 | | |
| 54 | | Platform Occupant Load | =C52+C53+D51+D52+D53+E52+F51+F52+F53 | | | | | |
| 55 | | | | | | | | |
| 56 | | | | | | | | |
| 57 | | | | | | | | |
| 58 | | | | | | | | |
| 59 | | | | | | | | |
| 60 | | | | | | | | |
| 61 | | | | | | | | |
| 62 | | | | | | | | |
| 63 | | | | | | | | |
| 64 | | | | | | | | |
| 65 | | | | | | | | |
| 66 | | | | | | | | |
| 67 | | | | | | | | |
| 68 | | | | | | | | |

Diagram illustrating the platform layout and direction of travel:

- Top Train: TRAIN (moving right)
- Bottom Train: TRAIN (moving left)
- Platform Occupant Load: $=\text{MAX}(C27, C36, C45, C54)$
- Direction: Northbound -Peak Direction - a.m.

APPENDIX A, TABLE D-3 : MULTI-SERVICE CENTRE PLATFORM

| | A | B | C | D | E | F | G | |
|----|---|----------------------------|--------------------------------------|------------------------|--------------------------|--------------------------|-----------|--|
| 1 | | | | | | | | |
| 2 | | Surge Factor | C2 | | | | | |
| 3 | | Crush Train Load (Persons) | C3 | | | | | |
| 4 | | Train Headway (min.) | C4 | | | | | |
| 5 | | | | | | | | |
| 6 | | | | | | | | |
| 7 | | | | a. m. | | | | |
| 8 | | | | NORTH BOUND (OFF-PEAK) | | SOUTH BOUND (PEAK) | | |
| 9 | | | | Service A | Service B | Service A | Service B | |
| 10 | | Link Load (Persons/Hour) | C9 | D9 | E9 | F9 | | |
| 11 | | Entraining (Persons/Hour) | C10 | D10 | E10 | F10 | | |
| 12 | | Transfer (Persons/Hour) | | | | | | |
| 13 | | From Service A (NB) To | | D12 | | F12 | | |
| 14 | | From Service A (SB) To | | D13 | | F13 | | |
| 15 | | From Service B (NB) To | C14 | | E14 | | | |
| 16 | | From Service B (SB) To | C15 | | E15 | | | |
| 17 | | Arrival Time-lag (minutes) | | | | | | |
| 18 | | After Service A | | D17 | | F17 | | |
| 19 | | After Service B | C18 | | E18 | | | |
| 20 | | Scenario 5: | | | | | | |
| 21 | | Northbound | | | | | | |
| 22 | | - Service A at Platform | | | | | | |
| 23 | | Southbound | | | | | | |
| 24 | | - Service A at Platform | | | | | | |
| 25 | | Calculated Train Load | =MIN((C9/60*C2*C4),C3) | | =MIN((E9/60*C2*C4*2),C3) | | | |
| 26 | | Entraining Load | =C10/60*C2*C4 | =D10/60*C2*(C4-D17) | =E10/60*C2*C4*2 | =F10/60*C2*(C4*2-F17) | | |
| 27 | | Transfer Load | =C14/60*C2*C4 | | =(E14*2+E15)/60*C2*C4 | =F12/60*C2*C4 | | |
| 28 | | Platform Occupant Load | =C24+C25+C26+D25+E24+E25+E26+F25+F26 | | | | | |
| 29 | | Scenario 6: | | | | | | |
| 30 | | Northbound | | | | | | |
| 31 | | - Service A at Platform | | | | | | |
| 32 | | Southbound | | | | | | |
| 33 | | - Service B at Platform | | | | | | |
| 34 | | Calculated Train Load | | =MIN((D9/60*C2*C4),C3) | =E24 | | | |
| 35 | | Entraining Load | =C10/60*C2*(C4-C18) | =D10/60*C2*C4 | =E25 | =F25 | | |
| 36 | | Transfer Load | =C14/60*C2*C4 | | =(E14*2)/60*C2*C4 | =(F12*2+F13)/60*C2*C4 | | |
| 37 | | Platform Occupant Load | =C34+C35+D33+D34+E33+E34+E35+F34+F35 | | | | | |
| 38 | | Scenario 7: | | | | | | |
| 39 | | Northbound | | | | | | |
| 40 | | - Service B at Platform | | | | | | |
| 41 | | Southbound | | | | | | |
| 42 | | - Service A at Platform | | | | | | |
| 43 | | Calculated Train Load | =C24 | | | =MIN((F9/60*C2*C4*2),C3) | | |
| 44 | | Entraining Load | =C25 | =D25 | =E10/60*C2*(C4*2-E18) | =F10/60*C2*C4*2 | | |
| 45 | | Transfer Load | | =D12/60*C2*C4 | =(E14*2+E15)/60*C2*C4 | =(F12*2)/60*C2*C4 | | |
| 46 | | Platform Occupant Load | =C42+C43+D43+D44+E43+E44+F42+F43+F44 | | | | | |
| 47 | | Scenario 8: | | | | | | |
| 48 | | Northbound | | | | | | |
| 49 | | - Service B at Platform | | | | | | |
| 50 | | Southbound | | | | | | |
| 51 | | - Service B at Platform | | | | | | |
| 52 | | Calculated Train Load | | =D33 | | =F42 | | |
| 53 | | Entraining Load | =C34 | =D34 | =E43 | =F43 | | |
| 54 | | Transfer Load | | =D12/60*C2*C4 | =E14/60*C2*C4 | =(F12*2+F13)/60*C2*C4 | | |
| 55 | | Platform Occupant Load | =C52+D51+D52+D53+E52+E53+F51+F52+F53 | | | | | |
| 56 | | | | | | | | |
| 57 | | | | | | | | |
| 58 | | | | | | | | |
| 59 | | | | | | | | |
| 60 | | | | | | | | |
| 61 | | | | | | | | |
| 62 | | | | | | | | |
| 63 | | | | | | | | |
| 64 | | | | | | | | |
| 65 | | | | | | | | |
| 66 | | | | | | | | |
| 67 | | | | | | | | |
| 68 | | | | | | | | |

Diagram illustrating the platform layout and direction of travel (TRAIN) for the Southbound - Peak Direction - a.m. scenario. The Platform Occupant Load is calculated as $\text{MAX}(C27, C36, C45, C54)$.

APPENDIX A, TABLE D-4 : MULTI-SERVICE CENTRE PLATFORM

| | A | B | C | D | E | F | G |
|----|---|----------------------------|----|---|---|---|---|
| 1 | | | | | | | |
| 2 | | Surge Factor | C2 | | | | |
| 3 | | Crush Train Load (Persons) | C3 | | | | |
| 4 | | Train Headway (min.) | C4 | | | | |
| 5 | | | | | | | |
| 6 | | | | | | | |
| 7 | | | | | | | |
| 8 | | | | | | | |
| 9 | | | | | | | |
| 10 | | | | | | | |
| 11 | | | | | | | |
| 12 | | | | | | | |
| 13 | | | | | | | |
| 14 | | | | | | | |
| 15 | | | | | | | |
| 16 | | | | | | | |
| 17 | | | | | | | |
| 18 | | | | | | | |
| 19 | | | | | | | |
| 20 | | | | | | | |
| 21 | | | | | | | |
| 22 | | | | | | | |
| 23 | | | | | | | |
| 24 | | | | | | | |
| 25 | | | | | | | |
| 26 | | | | | | | |
| 27 | | | | | | | |
| 28 | | | | | | | |
| 29 | | | | | | | |
| 30 | | | | | | | |
| 31 | | | | | | | |
| 32 | | | | | | | |
| 33 | | | | | | | |
| 34 | | | | | | | |
| 35 | | | | | | | |
| 36 | | | | | | | |
| 37 | | | | | | | |
| 38 | | | | | | | |
| 39 | | | | | | | |
| 40 | | | | | | | |
| 41 | | | | | | | |
| 42 | | | | | | | |
| 43 | | | | | | | |
| 44 | | | | | | | |
| 45 | | | | | | | |
| 46 | | | | | | | |
| 47 | | | | | | | |
| 48 | | | | | | | |
| 49 | | | | | | | |
| 50 | | | | | | | |
| 51 | | | | | | | |
| 52 | | | | | | | |
| 53 | | | | | | | |
| 54 | | | | | | | |
| 55 | | | | | | | |
| 56 | | | | | | | |
| 57 | | | | | | | |
| 58 | | | | | | | |
| 59 | | | | | | | |
| 60 | | | | | | | |
| 61 | | | | | | | |
| 62 | | | | | | | |
| 63 | | | | | | | |
| 64 | | | | | | | |
| 65 | | | | | | | |
| 66 | | | | | | | |
| 67 | | | | | | | |
| 68 | | | | | | | |

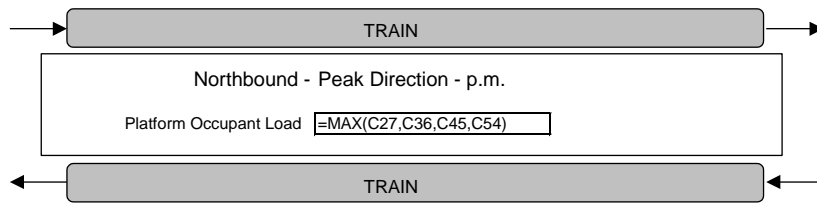

APPENDIX A, TABLE D-5 : MULTI-SERVICE CENTRE PLATFORM

| | A | B | C | D | E | F | G | |
|----|---|-----------------------------------|--------------------------------------|-------------------------------|--------------------------|---------------------------|------------------|--|
| 1 | | | | | | | | |
| 2 | | Surge Factor | C2 | | | | | |
| 3 | | Crush Train Load (Persons) | C3 | | | | | |
| 4 | | Train Headway (min.) | C4 | | | | | |
| 5 | | | | | | | | |
| 6 | | | | | | | | |
| 7 | | | | p. m. | | | | |
| 8 | | | | NORTH BOUND (OFF-PEAK) | | SOUTH BOUND (PEAK) | | |
| 9 | | | | Service A | Service B | Service A | Service B | |
| 10 | | Link Load (Persons/Hour) | C9 | D9 | E9 | F9 | | |
| 11 | | Entraining (Persons/Hour) | C10 | D10 | E10 | F10 | | |
| 12 | | Transfer (Persons/Hour) | | | | | | |
| 13 | | From Service A (NB) To | | D12 | | F12 | | |
| 14 | | From Service A (SB) To | | D13 | | F13 | | |
| 15 | | From Service B (NB) To | C14 | | E14 | | | |
| 16 | | From Service B (SB) To | C15 | | E15 | | | |
| 17 | | Arrival Time-lag (minutes) | | | | | | |
| 18 | | After Service A | | D17 | | F17 | | |
| 19 | | After Service B | C18 | | E18 | | | |
| 20 | | Scenario 13: | | | | | | |
| 21 | | Northbound | | | | | | |
| 22 | | - Service A at Platform | | | | | | |
| 23 | | Southbound | | | | | | |
| 24 | | - Service A at Platform | | | | | | |
| 25 | | Calculated Train Load | =MIN((C9/60*C2*C4),C3) | | =MIN((E9/60*C2*C4*2),C3) | | | |
| 26 | | Entraining Load | =C10/60*C2*C4 | =D10/60*C2*(C4-D17) | =E10/60*C2*C4*2 | =F10/60*C2*(C4*2-F17) | | |
| 27 | | Transfer Load | =C14/60*C2*C4 | | =E14*2+E15/60*C2*C4 | =F12/60*C2*C4 | | |
| 28 | | Platform Occupant Load | =C24+C25+C26+D25+E24+E25+E26+F25+F26 | | | | | |
| 29 | | Scenario 14: | | | | | | |
| 30 | | Northbound | | | | | | |
| 31 | | - Service A at Platform | | | | | | |
| 32 | | Southbound | | | | | | |
| 33 | | - Service B at Platform | | | | | | |
| 34 | | Calculated Train Load | | =MIN((D9/60*C2*C4),C3) | =E24 | | | |
| 35 | | Entraining Load | =C10/60*C2*(C4-C18) | =D10/60*C2*C4 | =E25 | =F25 | | |
| 36 | | Transfer Load | =C14/60*C2*C4 | | =E14*2/60*C2*C4 | =F12*2+F13/60*C2*C4 | | |
| 37 | | Platform Occupant Load | =C34+C35+D33+D34+E33+E34+E35+F34+F35 | | | | | |
| 38 | | Scenario 15: | | | | | | |
| 39 | | Northbound | | | | | | |
| 40 | | - Service B at Platform | | | | | | |
| 41 | | Southbound | | | | | | |
| 42 | | - Service A at Platform | | | | | | |
| 43 | | Calculated Train Load | =C24 | | | =MIN((F9/60*C2*C4*2),C3) | | |
| 44 | | Entraining Load | =C25 | =D25 | =E10/60*C2*(C4*2-E18) | =F10/60*C2*C4*2 | | |
| 45 | | Transfer Load | | =D12/60*C2*C4 | =E14*2+E15/60*C2*C4 | =F12*2/60*C2*C4 | | |
| 46 | | Platform Occupant Load | =C42+C43+D43+D44+E43+E44+F42+F43+F44 | | | | | |
| 47 | | Scenario 16: | | | | | | |
| 48 | | Northbound | | | | | | |
| 49 | | - Service B at Platform | | | | | | |
| 50 | | Southbound | | | | | | |
| 51 | | - Service B at Platform | | | | | | |
| 52 | | Calculated Train Load | | =D33 | | =F42 | | |
| 53 | | Entraining Load | =C34 | =D34 | =E43 | =F43 | | |
| 54 | | Transfer Load | | =D12/60*C2*C4 | =E14/60*C2*C4 | =F12*2+F13/60*C2*C4 | | |
| 55 | | Platform Occupant Load | =C52+D51+D52+D53+E52+E53+F51+F52+F53 | | | | | |
| 56 | | | | | | | | |
| 57 | | | | | | | | |
| 58 | | | | | | | | |
| 59 | | | | | | | | |
| 60 | | | | | | | | |
| 61 | | | | | | | | |
| 62 | | | | | | | | |
| 63 | | | | | | | | |
| 64 | | | | | | | | |
| 65 | | | | | | | | |
| 66 | | | | | | | | |
| 67 | | | | | | | | |
| 68 | | | | | | | | |

Diagram illustrating the platform layout and load calculation for the Southbound - Peak Direction - p.m. scenario. The platform occupant load is calculated as the maximum of C27, C36, C45, and C54.

**APPENDIX A, FIGURE 1
MULTI-SERVICE SIDE PLATFORM**

**TRANSFER LOAD AT PLATFORM
(SERVICE A ARRIVED AT PLATFORM - TABLE C)**

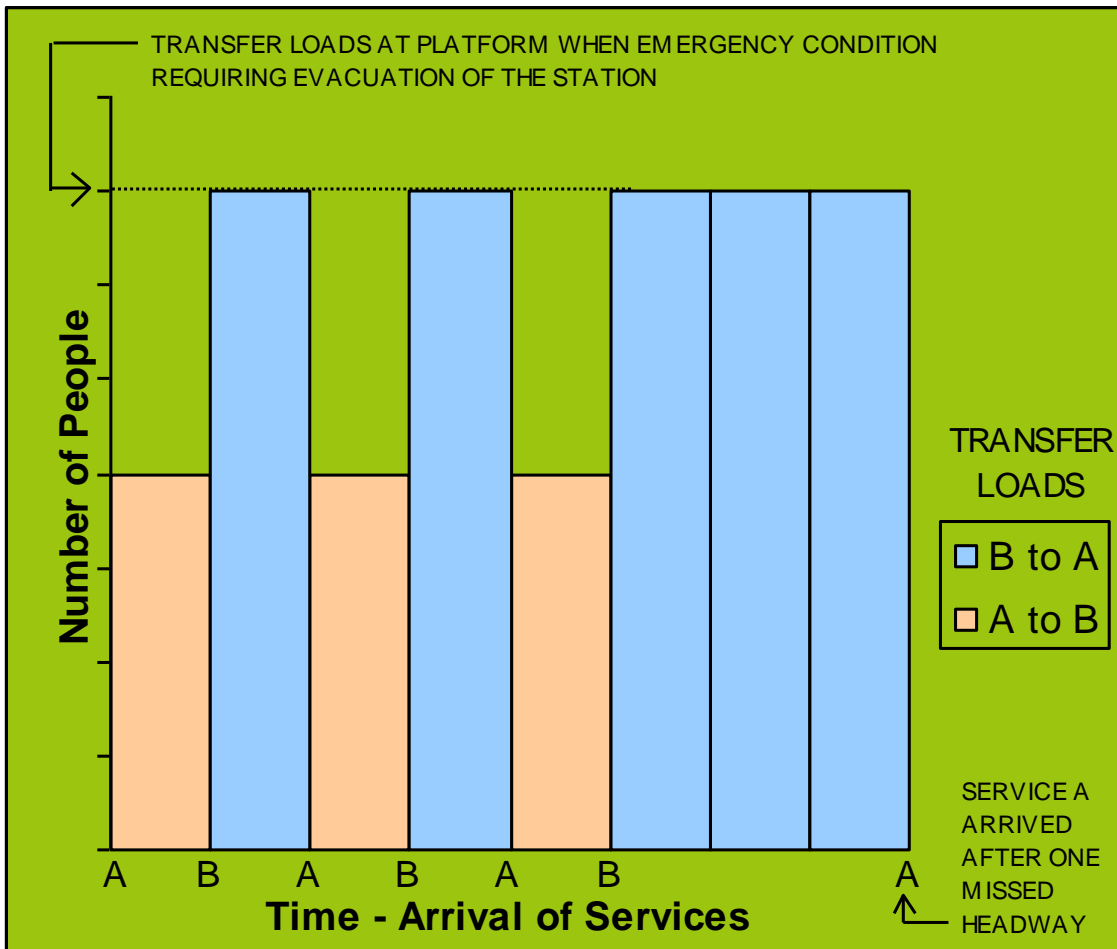

**APPENDIX A, FIGURE 2
MULTI-SERVICE CENTRE PLATFORM**

**TRANSFER LOADS AT PLATFORM
(SCENARIO 1 OF TABLE D-2)**

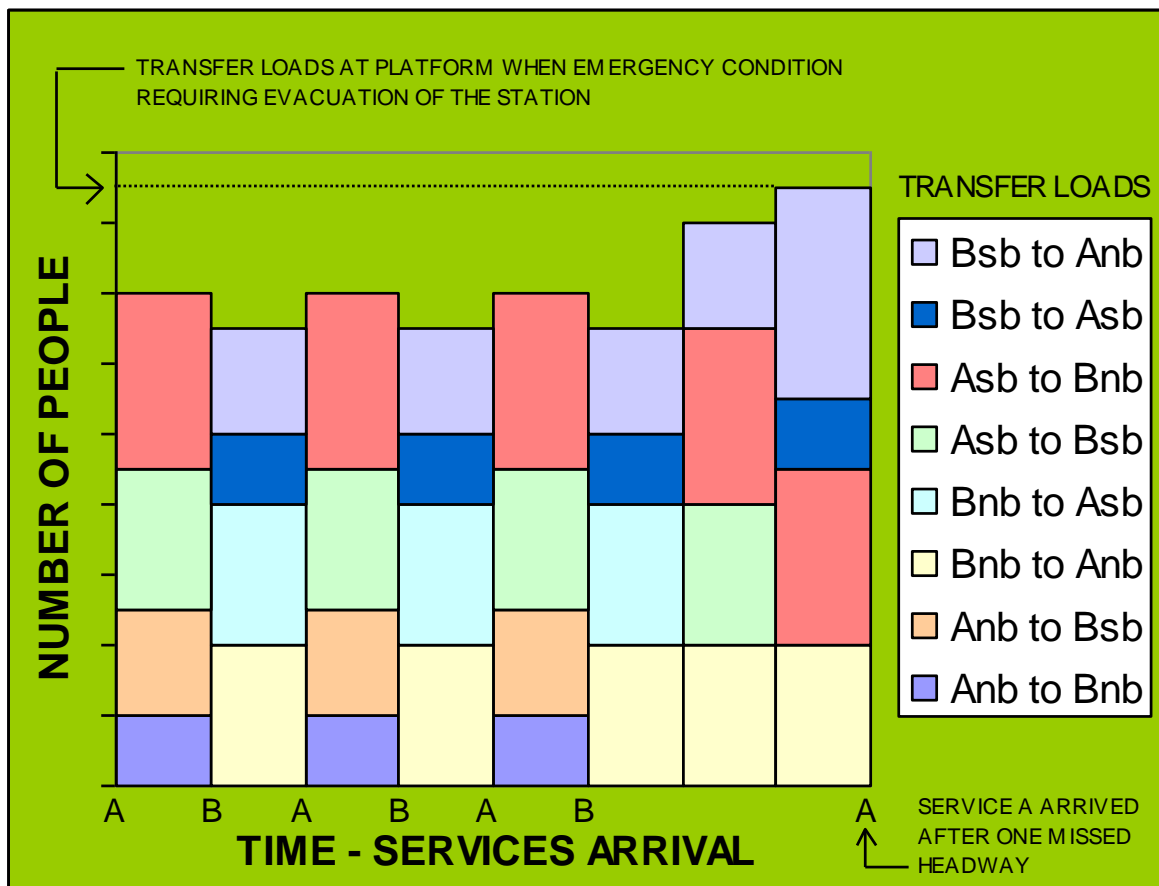

APPENDIX B EXITING ANALYSIS

B.1 GENERAL

B.1.1 As described in Section 2.2, there shall be sufficient exit capacity to clear the platform occupant load from the station platform in 4 minutes or less, and the station shall be designed to permit evacuation from the most remote point of the platform to a point of safety in 6 minutes or less.

B.1.2 Platform exit time is the time required to clear all the platform occupant load from the platform according to the formula:

$$\begin{aligned} &\text{Time to clear platform} \\ &= \text{Platform exits flow time} \\ &= \text{Platform Occupant Load} / \text{Platform Exit Capacity} \end{aligned}$$

B.1.3 The time to evacuate from the most remote point of the platform to a point of safety is the sum of the walking travel time for the longest exit route plus the waiting times at the various circulation elements.

B.1.4 The walking travel time is calculated using station geometry data and the travel speeds indicated in Cl.2.2.3.7. The exit route is broken down into segments and tabulated. The travel distance for each segment is then divided by the appropriate travel speed to determine the time needed to traverse each segment. The walking travel time is the sum of the times for each segment.

B.1.5 The flow time (the time for the last person to through the particular element) for each of the various circulation elements (e.g. stairs/escalators, fare collection gates, doors, etc.) is calculated using the capacities and conditions specified in Section 2.2 along with the occupant load calculated as described in Appendix A.

B.1.6 Care must be taken to be sure that the most restrictive circulation elements are included in the calculations.

For instance, if a 1000mm wide single-leaf door provides access to a 1200mm wide stair, the door and the stair would be considered to provide a capacity of 80p/min and 72p/min respectively in accordance with Cl.2.2.3.7. In this case the stair is more restrictive than the door, meaning that the stair shall be used in the capacity calculation.

Time to clear platform/
Platform exits flow time

Station evacuation time

Walking travel time

Flow time

B.1.7 Where exit paths divide, i.e., where a choice of exit paths is presented, it is presumed that the passengers will divide into groups roughly in proportion to the exit capacity provided by the various paths at the decision point. It also is presumed that passengers, once having made a decision (selecting an exit path), will stay on that path until another decision point is reached or egress is achieved.

B.1.8 The waiting time at each of the various circulation elements is calculated, for the platform exits, by subtracting the walking travel time on the platform from the platform exits flow time, and for each of the remaining circulation elements, by subtracting the maximum of all previous element flow times.

Waiting time
at circulation
elements

B.2 CENTRE PLATFORM STATION

B.2.1 The sample centre platform station shown in Figure B-2.1 is an underground station with the concourse above the platform level but below grade. The platform public area is 60m long to accommodate the train length. The vertical distance from the platform to the concourse is 5m. The vertical distance from concourse to grade is 8m.

The station has two entrances normally used by passengers. Each of these entrances has two escalators of 1m clear width and one stair of 2m clear width. The entrances are covered at grade level to a point 9m beyond the top of the stair landing.

The station concourse level has one paid area separated from the unpaid area. At two ends of the paid area, there are 8 electronic fare gates and a 1-m wide emergency gate. The open well at the centre of the concourse level communicate with the platform level. Each end has one stair of 2m clear width and two escalators of 1m clear width. Station ancillary areas are located at the two ends of the platform and concourse level.

The station occupant load is 1200 persons.

In Test #1 of Figure B-2.2, the time to clear the platform is found to be 2.86 minutes. This meets the requirement of Cl.2.2.3.3. The sample calculation shows the effect of discounting one of the escalators from platform to concourse for the escape route to the right of the station.

In Test #2 of Figure B-2.2, the time to reach a point outside



any enclosing structure for Escape Route 1 and Escape Route 2 are found to be 4.45 minutes. They meet the requirement of Cl. 2.2.3.4.

Additional calculations must also be made to examine the results of discounting an escalator at other locations to verify that the exit time under those conditions can still comply with Cl. 2.2.3.4.

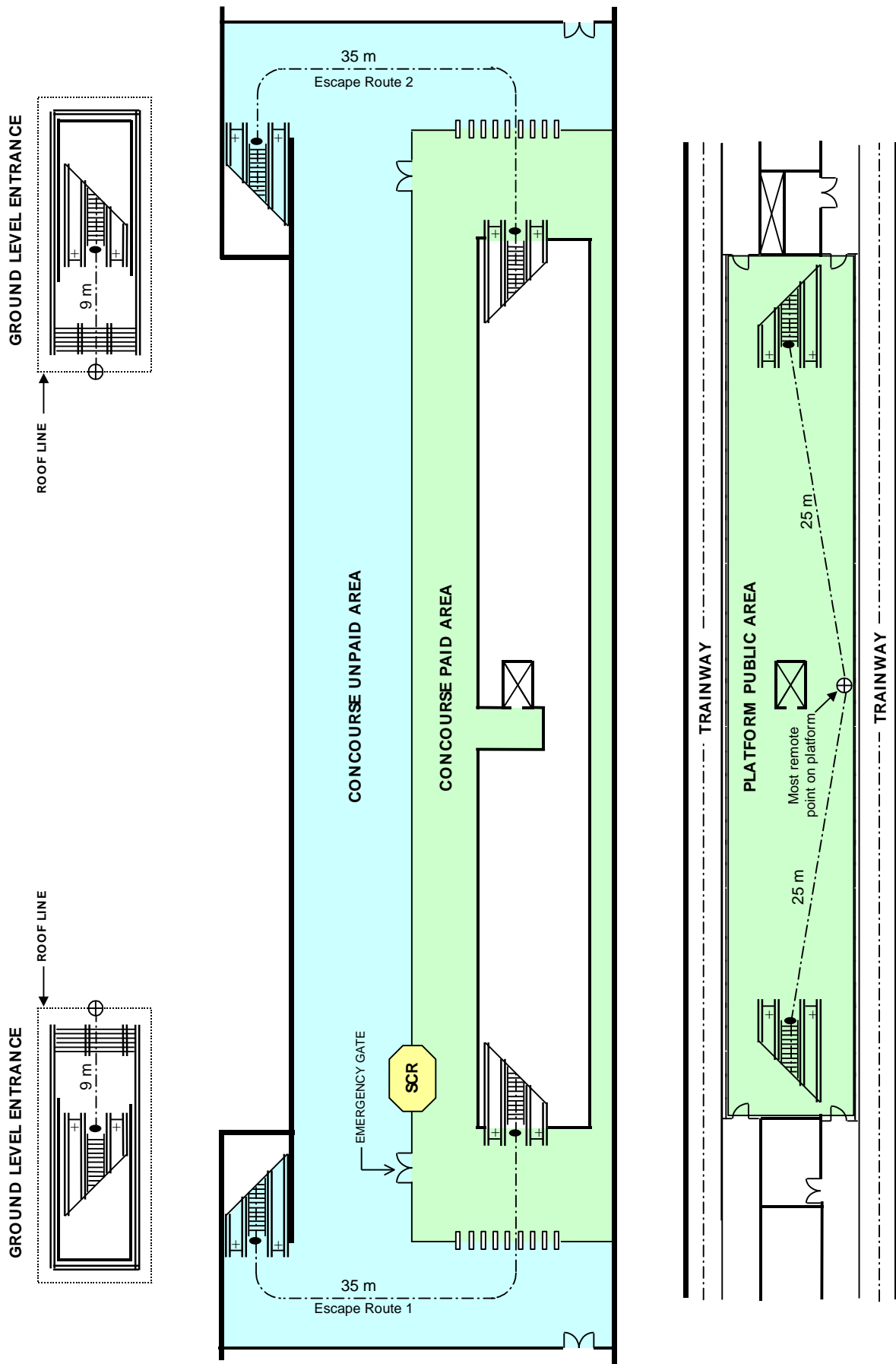

FIGURE B-2.1 CENTRE PLATFORM STATION

TEST #1

PLATFORM EXIT CAPACITY
 = $(240 + 180) \text{ p/min}$
 = 420 p/min

TIME TO CLEAR PLATFORM (Wf)
 = Platform Occupant Load ÷ Platform Exit Capacity
 = $1200 \text{ persons} \div 420 \text{ p/min}$
 = 2.86 minutes

TEST #2 FOR ESCAPE ROUTE 1

TOTAL WALKING TIME ($T = T1+T2+T3+T4+T5$)

| | m | m/min | minutes |
|-----------------------|----|-------|-------------|
| On Platform | 71 | 25 | 60 |
| Platform to Concourse | 72 | 5 | 15 |
| On Concourse | 73 | 35 | 60 |
| Concourse to Grade | 74 | 8 | 15 |
| On Grade to Safe Area | 75 | 9 | 60 |
| | | | <u>2.01</u> |

TOTAL EXIT TIME = $T + Wp + Wf + Wc$
 = $2.01 + 2.44 + 0.00 + 0.00$
 = 4.45 minutes

TEST #2 FOR ESCAPE ROUTE 2

TOTAL WALKING TIME ($T = T1+T2+T3+T4+T5$)

| | m | m/min | minutes |
|-----------------------|----|-------|-------------|
| On Platform | 71 | 25 | 60 |
| Platform to Concourse | 72 | 5 | 15 |
| On Concourse | 73 | 35 | 60 |
| Concourse to Grade | 74 | 8 | 15 |
| On Grade to Safe Area | 75 | 9 | 60 |
| | | | <u>2.01</u> |

TOTAL EXIT TIME = $T + Wp + Wf + Wc$
 = $2.01 + 2.44 + 0.00 + 0.00$
 = 4.45 minutes

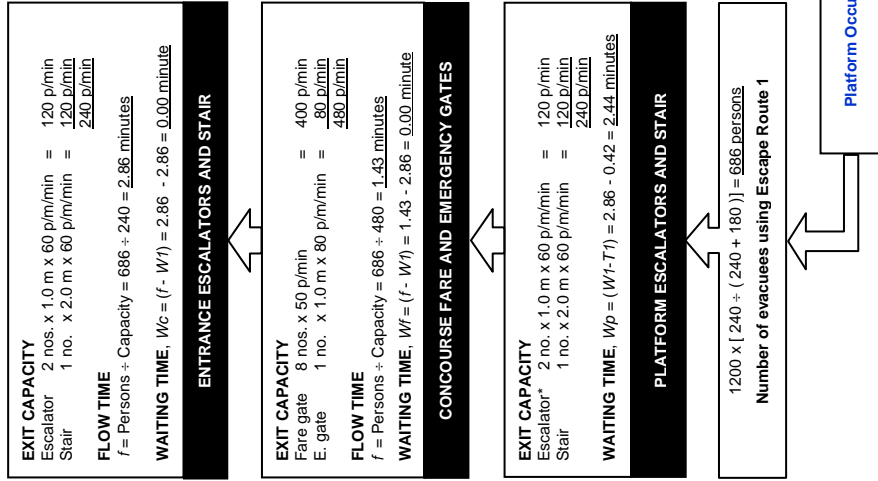

* One escalator is discounted

FIGURE B-2.2 EXITING ANALYSIS

APPENDIX C NOTIONAL PERIODS OF FIRE RESISTANCE

In this Appendix:

- (a) "Class 1 aggregate" means foamed slag, pumice, blast furnace slag, pelleted fly ash, crushed brick and burnt clay products (including expanded clay) well-burnt clinker and crushed limestone. "Class 2 aggregate" means flint gravel, granite, and all crushed natural stones other than limestones.
- (b) Any reference to plaster means:
- (i) In the case of an external wall 1m or more from the relevant boundary, plaster applied on the internal face only;
 - (ii) In the case of any other wall, plaster applied on both faces;
 - (iii) If to plaster of a given thickness on the external face of a wall, except in the case of a reference to vermiculite-gypsum plaster, rendering on the external face of the same thickness;
 - (iv) If to vermiculite-gypsum plaster, vermiculite-gypsum plaster of a mix within the range of 1 ½ to 2:1 by volume.
- (c) In the case of a cavity wall, the load is assumed to be on inner leaf only except for fire resistance period of four hours.
- (d) Any material or type of construction or method of mixing, preparing, using, applying or fixing the material as referred to in the table, shall conform with the relevant provisions of the Building Control Regulations, 1989 and the relevant Singapore Standard or Singapore Standard Code of Practice in respect of the material or such matters. In the absence of a Singapore Standard or Singapore Code of Practice on the material or such matters, the relevant British Standard or British Code of Practice or other accepted Standard or Code of Practice shall be applicable.

PART I : WALLS

A. Masonry construction:

| Construction and materials | Minimum thickness excluding plaster (in mm) for period of fire resistance of | | | | | |
|--|--|---------|--------|-----------------|---------|--------|
| | Loadbearing | | | Non-loadbearing | | |
| | 4 hours | 2 hours | 1 hour | 4 hours | 2 hours | 1 hour |
| 1. Reinforced concrete, minimum concrete cover to main reinforcement of 25 mm: | | | | | | |
| (a) Unplastered (to comply with SS CP 65 Part 2) | - | - | - | - | - | - |
| (b) 12.5mm cement-sand plaster | 180 | 100 | 75 | - | - | - |
| (c) 12.5mm gypsum-sand plaster | 180 | 100 | 75 | - | - | - |
| (d) 12.5mm vermiculite-gypsum plaster | 125 | 75 | 63 | - | - | - |
| 2. No-fines concrete of Class 2 aggregate: | | | | | | |
| (a) 13mm cement-sand plaster | - | - | - | 150 | 150 | 150 |
| (b) 13mm gypsum-sand plaster | - | - | - | 150 | 150 | 150 |
| (c) 13mm vermiculite-gypsum plaster | - | - | - | 150 | 150 | 150 |
| 3. Bricks of clay, concrete or sand - lime: | | | | | | |
| (a) Unplastered | 200 | 100 | 100 | 170 | 100 | 75 |
| (b) 13mm cement-sand plaster | 200 | 100 | 100 | 170 | 100 | 75 |
| (c) 13mm gypsum-sand plaster | 200 | 100 | 100 | 170 | 100 | 75 |
| (d) 13mm vermiculite-gypsum or perlite-gypsum plaster | 100 | 100 | 100 | 100 | 100 | 75 |

APPENDIX C - continued

PART I : WALLS - continued

A. Masonry construction - continued

| Construction and materials | Minimum thickness excluding plaster (in mm) for period of fire resistance of | | | | | |
|---|--|---------|--------|-----------------|---------|--------|
| | Loadbearing | | | Non-loadbearing | | |
| | 4 hours | 2 hours | 1 hour | 4 hours | 2 hours | 1 hour |
| 4. Concrete blocks of Class 1 aggregate: | | | | | | |
| (a) Unplastered | 150 | 100 | 100 | 150 | 75 | 75 |
| (b) 12.5mm cement-sand plaster | 150 | 100 | 100 | 100 | 75 | 75 |
| (c) 12.5mm gypsum-sand plaster | 150 | 100 | 100 | 100 | 75 | 75 |
| (d) 12.5mm vermiculite-gypsum plaster | 100 | 100 | 100 | 75 | 75 | 50 |
| 5. Concrete blocks of Class 2 aggregate: | | | | | | |
| (a) Unplastered | - | 100 | 100 | 150 | 100 | 75 |
| (b) 12.5mm cement-sand plaster | - | 100 | 100 | 150 | 100 | 75 |
| (c) 12.5mm gypsum-sand plaster | - | 100 | 100 | 150 | 100 | 75 |
| (d) 12.5mm vermiculite-gypsum plaster | 100 | 100 | 100 | 100 | 75 | 75 |
| 6. Autoclaved aerated concrete blocks, density 475 - 1200 kg/m ³ | 180 | 100 | 100 | 100 | 62 | 50 |
| 7. Hollow concrete blocks, one cell in wall thickness, of Class 1 aggregate: | | | | | | |
| (a) 12.5mm cement-sand plaster | - | 100 | 100 | 150 | 100 | 100 |
| (b) 12.5mm gypsum-sand plaster | - | 100 | 100 | 150 | 100 | 75 |
| (c) 12.5mm gypsum-sand plaster | - | 100 | 100 | 150 | 100 | 75 |
| (d) 12.5mm vermiculite-gypsum plaster | - | 100 | 100 | 100 | 75 | 62 |
| 8. Hollow concrete blocks, one cell in wall thickness, of Class 2 aggregate: | | | | | | |
| (a) Unplastered | - | - | - | 150 | 150 | 125 |
| (b) 12.5mm cement-sand plaster | - | - | - | 150 | 150 | 125 |
| (c) 12.5mm gypsum-sand plaster | - | - | - | 150 | 150 | 125 |
| (d) 12.5mm vermiculite-gypsum plaster | - | - | - | 125 | 100 | 100 |
| 9. Cellular clay blocks not less than 50% solid: | | | | | | |
| (a) 12.5mm cement-sand plaster | - | - | - | - | - | 100 |
| (b) 12.5mm gypsum-sand plaster | - | - | - | - | - | 100 |
| (c) 12.5mm vermiculite-gypsum plaster | - | - | - | 200 | 100 | 100 |
| 10. Cavity wall with outer leaf of bricks or blocks of clay, composition, concrete or sand-lime, not less than 100 mm thick and ; | | | | | | |
| (a) inner leaf of bricks or blocks of clay, composition, concrete or sand-lime | 100 | 100 | 100 | 75 | 75 | 75 |
| (b) inner leaf of solid or hollow concrete bricks or blocks of Class 1 aggregate | 100 | 100 | 100 | 75 | 75 | 75 |
| 11. Cavity wall with outer leaf of cellular clay blocks as 9 above and inner leaf of autoclaved aerated concrete blocks, density 480-1200 Kg/m ³ | 150 | 100 | 100 | 75 | 75 | 75 |

APPENDIX C - continued

PART I : WALLS - continued

| B | Construction and materials | Period of fire resistance (in hours) |
|---|---|--|
| | 1. Steel frame with external cladding of 16mm rendering on metal lathing and internal lining of autoclaved aerated concrete blocks, density 480-1120 Kg/cu.m. of thickness of - | |
| | 50mm ----- | 2 |
| | 75mm ----- | 4 |
| | 2. Steel frame with external cladding of 100mm concrete blocks and internal lining of 16mm gypsum plaster on metal lathing ----- | 4 |
| | 3. Steel frame with external cladding of 16mm rendering on metal lathing and internal lining of 16mm gypsum plaster on metal lathing ----- | 1 |
| | 4. Steel frame with facings on each side of: - | |
| | (a) metal lathing with cement-sand or gypsum plaster of thickness of 19mm ----- | 1 |
| | (b) metal lathing with vermiculite-gypsum or perlite-gypsum of thickness of - | |
| | 25mm ----- | 2 |
| | 12.5mm ----- | 1 |
| | (c) 9.5mm plasterboard with vermiculite-gypsum of thickness of - | |
| | 25mm ----- | 2 |
| | 10mm ----- | 1 |
| | (d) 12.5mm plasterboard with gypsum plaster of thickness of 12.5mm ----- | 1 |
| | (e) 12.5mm plasterboard with vermiculite-gypsum plaster of thickness of - | |
| | 25mm ----- | 2 |
| | 10mm ----- | 1 |
| | (f) 19mm plasterboard (or two layers of 9.5mm fixed to break joint) without finish ----- | 1 |
| | (g) 19mm plasterboard for two layers of 9.5mm with vermiculite-gypsum plaster of thickness of 16mm ----- | 2 |
| | 6. Plasterboard 9.5mm cellular core partition with 22mm vermiculite-gypsum plaster ----- | 2 |
| | 7. Plasterboard 12.5mm cellular core partition | |
| | (a) 12.5mm gypsum plaster ----- | 1 |
| | (b) 16mm vermiculite-gypsum plaster ----- | 2 |
| | 8. Plasterboard 19mm finished on both faces with 16mm gypsum plaster ----- | 1 |
| | 9. Three layers of 19mm plasterboard bonded with heat gypsum plaster ----- | 2 |

APPENDIX C - continued

PART II : REINFORCED CONCRETE BEAMS

| Description | Minimum dimension of concrete to give a fire resistance in hours | | |
|--|--|-----|----|
| | 4 | 2 | 1 |
| | mm | mm | mm |
| 1. Reinforced concrete beams without any protection shall comply with SS CP 65 Part 2. | - | - | - |
| 2. As (1) with cement or gypsum plaster 15mm thick on light mesh reinforcement | | | |
| (a) average concrete cover to main reinforcement | 50* | 30 | 15 |
| (b) beam width | 250 | 170 | 85 |
| 3. As (1) with vermiculite/gypsum plaster** 15mm thick: | | | |
| (a) average concrete cover to main reinforcement | 25 | 15 | 15 |
| (b) beam width | 170 | 125 | 60 |
| 4. Light weight concrete shall comply with SS CP 65 Part 2. | - | - | - |

* Supplementary reinforcement, to hold the concrete cover in position, may be necessary.

** Vermiculite/gypsum plaster should have a mix ratio in the range of 1 ½ - 2:1 by volume.

APPENDIX C - continued

PART III : PRESTRESSED CONCRETE BEAMS

| Description | Minimum dimension of concrete to give a fire resistance in hours | | |
|---|--|-----|----|
| | 4 | 2 | 1 |
| | mm | mm | mm |
| 1. Prestressed concrete beams without any protection shall comply with SS CP 65 Part 2. | - | - | - |
| 2. As (1) with vermiculite concrete slabs 15mm thick, used as permanent shuttering: | | | |
| (a) average concrete cover to tendons | 75* | 45 | 25 |
| (b) beam width | 210 | 125 | 70 |
| 3. As (2) but with 25mm thick slabs: | | | |
| (a) average concrete cover to tendons | 65 | 35 | 15 |
| (b) beam width | 180 | 100 | 60 |
| 4. As (1) with 15mm thick gypsum plaster with light mesh reinforcement: | | | |
| (a) average concrete cover to tendons | 90* | 50 | 30 |
| (b) beam width | 250 | 170 | 85 |
| 5. As (1) with vermiculite/gypsum plaster** 15m thick: | | | |
| (a) average concrete cover to tendons | 75* | 45 | 25 |
| (b) beam width | 170 | 125 | 60 |
| 6. As (5) but with 25mm thick coating: | | | |
| (a) average concrete cover to tendons | 50 | 30 | 15 |
| (b) beam width | 140 | 85 | 60 |
| 7. Prestressed lightweight concrete without any protection shall comply with SS CP 65 Part 2. | - | - | - |

* Supplementary reinforcement, to hold the concrete cover in position, may be necessary.

** Vermiculite/gypsum plaster should have a mix ratio in the range of 1 ½ - 2:1 by volume.

APPENDIX C - continued

PART IV : REINFORCED CONCRETE COLUMNS (ALL FACES EXPOSED)

| Type of construction | Minimum dimension of concrete to give a fire resistance in hours | | |
|--|--|-----|-----|
| | 4 | 2 | 1 |
| | mm | mm | mm |
| 1. Dense concrete: | | | |
| (a) without additional protection to comply with SS CP 65 Part 2 | - | - | - |
| (b) with cement or gypsum plaster 15mm thick on light mesh reinforcement | 300 | 225 | 150 |
| (c) with vermiculite/gypsum plaster* | 275 | 200 | 120 |
| 3. Lightweight aggregate concrete to comply with SS CP 65 Part 2 | - | - | - |

REINFORCED CONCRETE COLUMNS (ONE FACE EXPOSED)

| Type of construction | Minimum dimension of concrete to give a fire resistance in hours | | |
|--|--|----|----|
| | 4 | 2 | 1 |
| | mm | mm | mm |
| 1. Dense concrete: | | | |
| (a) without additional protection to comply with SS CP 65 Part 2 | - | - | - |
| (b) with Vermiculite/gypsum plaster* 15mm thick on exposed faces | 125 | 75 | 65 |

* Vermiculite/gypsum plaster should have a mix ratio in the range of 1 ½ - 2:1 by volume.

APPENDIX C - continued

PART V : STRUCTURAL STEEL

A. Encased steel stanchions (Mass per metre not less than 45 Kg)

| Construction and materials | Minimum thickness (in mm) of protection for a fire resistance of | | |
|--|--|-----------------|-----------|
| | 4 hours | 2 hours | 1 hour |
| A. SOLID PROTECTION* (unplastered) | | | |
| 1. Concrete not leaner than 1:2:4 mix with natural aggregates- | | | |
| (a) concrete not assumed to be load-bearing reinforced ⁺ | 50 | 25 | 25 |
| (b) concrete assumed to be load-bearing, reinforced in accordance with BS 5950: Part 8 | 75 | 50 | 50 |
| 2. Solid bricks of clay, composition or sand-lime | 100 | 50 | 50 |
| 3. Solid blocks of foamed slag or pumice concrete reinforced ⁺ in every horizontal joint | 75 | 50 | 50 |
| 4. Sprayed vermiculite-cement | - | 38 | 19 |
| B. HOLLOW PROTECTION⁺⁺ | | | |
| 1. Solid bricks of clay, composition or sand-lime reinforced in every horizontal joint, unplastered | 115 | 50 | 50 |
| 2. Solid blocks of foamed slag or pumice concrete reinforced ⁺ in every horizontal joint, unplastered | 75 | 50 | 50 |
| 3. Metal lathing with gypsum or cement-lime plaster of thickness of- | - | 38 [§] | 19 |
| 4. (a) Metal lathing with vermiculite-gypsum or perlite-gypsum plaster of thickness of | 50 [§] | 19 | 12.5 |
| (b) Metal lathing spaced 25mm from flanges with vermiculite-gypsum or perlite-gypsum plaster of thickness of | 44 | 19 | 12.5 |
| 5. Gypsum plasterboard with 1.6mm wire binding at 100mm pitch - | | | |
| (a) 9.5mm Plasterboard with gypsum plaster of thickness of | - | - | 12.5 |
| (b) 19mm Plasterboard with gypsum plaster of thickness of | - | 12.5 | 7 |
| 6. Gypsum plasterboard with 1.6mm wire binding at 100mm pitch- | | | |
| (a) 9.5mm plasterboard with vermiculite-gypsum plaster of thickness of | - | 16 | 10 |
| (b) 19mm plasterboard with vermiculite- gypsum plaster of thickness of | 38 [§] | 20 | 10 |
| 7. Vermiculite - cement slabs of 4:1 mix reinforced with wire mesh and finished with plaster skim. Slabs of thickness of | 63 | 25 | 25 |

* Solid protection means a casing which is bedded close to the steel without intervening cavities and with all joints in that casing made full and solid.

+ Reinforcement shall consist of steel binding wire not less than 2.3mm in thickness, or a steel mesh weighing not less than 0.48 kg/m². In concrete protection, the spacing of that reinforcement shall not exceed 150mm in any direction.

++ Hollow protection means that there is a void between the protective material and the steel. All hollow protection to columns shall be effectively sealed at each floor level.

§ Light mesh reinforcement required 12.5mm to 19mm below surface unless special corner beads are used.

APPENDIX C - continued

PART V : STRUCTURAL STEEL - continued

B. Encased steel beams (Mass per metre not less than 30 Kg)

| Construction and materials | Minimum thickness (in mm) of protection for a fire resistance of | | |
|--|--|------------|-----------|
| | 4 hours | 2 hours | 1 hour |
| A. SOLID PROTECTION⁺ (unplastered) | | | |
| 1. Concrete not leaner than 1:2:4 mix with natural aggregates - | | | |
| (a) concrete not assumed to be load-bearing, reinforced ⁺⁺ | 75 | 25 | 25 |
| (b) concrete assumed to be load-bearing, reinforced in accordance with BS 5950: Part 8 | 75 | 50 | 50 |
| 2. Sprayed vermiculite - cement | - | 38 | 19 |
| B. HOLLOW PROTECTION[*] | | | |
| 1. Metal lathing - | | | |
| (a) with cement-lime plaster of thickness of | - | 38 | 19 |
| (b) with gypsum plaster of thickness of | - | 22 | 16 |
| (c) with vermiculite-gypsum or perlite-gypsum plaster of thickness of | 32 | 12.5 | 12.5 |
| 2. Gypsum plasterboard with 1.6mm wire binding at 100 mm pitch - | | | |
| (a) 9.5mm plasterboard with gypsum plaster of thickness of | - | - | 12.5 |
| (b) 19 mm plasterboard with gypsum plaster of thickness of | - | 12.5 | 7 |
| 3. Plasterboard with 1.6mm wire at 100m pitch - | | | |
| (a) 9.5 mm plaster nailed to wooden cradles finished with gypsum plaster of thickness of | - | - | - |
| (b) 9.5 mm plasterboard with vermiculite - gypsum plaster of thickness of | - | 16 | 10 |
| (c) 19 mm plasterboard with vermiculite-gypsum plaster of thickness of | 32 | 10 | 7 |
| (d) 19 mm plasterboard with gypsum plaster of thickness of | - | 20 | 10 |
| 4. Vermiculite-cement slabs of 4:1 mix reinforced with wire mesh and finished with plaster skim. Slabs of thickness of | 63 | 25 | 25 |

* Hollow protection means that there is a void between the protective materials and the steel. All hollow protection to columns shall be effectively sealed at each floor level.

+ Solid protection means a casing which is bedded close to the steel without intervening cavities and with all joints in that casing made full and solid.

++ Reinforcement shall consist of steel binding wire not less than 2.3mm in thickness, or a steel mesh weighing not less than 0.48 kg/m². In concrete protection, the spacing of that reinforcement shall not exceed 150mm in any direction.

§ Light mesh reinforcement required 12.5mm to 19mm below surface unless special corner beads are used.

APPENDIX C - continued

PART VI : STRUCTURAL ALUMINIUM

Encased aluminium alloy stanchions and beams
(Mass per metre not less than 16 kg)

| Construction and materials | Minimum thickness (in mm) of protection for a fire resistance of | | |
|--|--|------------|-----------|
| | 4 hours | 2 hours | 1 hour |
| A. SOLID PROTECTION* | | | |
| 1. Sprayed vermiculite-cement | - | - | 44 |
| B. HOLLOW PROTECTION⁺ | | | |
| 1. Metal lathing with vermiculite-gypsum or perlite-gypsum plaster of thickness of | - | 32 | 16 |
| 2. Metal lathing finished with neat gypsum plaster of thickness of | - | - | 19 |
| 3. Gypsum plasterboard 19 mm thick with 1.6 mm wire binding at 100 mm pitch finished with gypsum-vermiculite plaster of thickness of | - | 22 | 10 |

* Solid protection means a casing which is bedded close to the alloy without intervening cavities and with all joints in that casing made full and solid.

+ Hollow protection means that there is a void between the protective material and the alloy. All hollow protection to columns shall be effectively sealed at each floor level.

PART VII : REINFORCED CONCRETE FLOORS (DENSE CONCRETE)

| Description | Minimum dimension to give fire resistance in | | |
|--|--|------------|-----------|
| | 4 hours | 2 hours | 1 hour |
| Solid floor slab, ribbed floor slab, hollow core slab to comply with SS CP 65 Part 2 | mm - | mm - | mm - |

APPENDIX C - continued

PART VIII : PRESTRESSED CONCRETE FLOORS (SILICEOUS OR CALCAREOUS AGGREGATE)

| Description | | Minimum dimension to give fire resistance in | | |
|--|---------------------------------------|--|---------|--------|
| | | 4 hours | 2 hours | 1 hour |
| | | mm | mm | mm |
| Solid slab | Average cover to reinforcement | 65* | 40 | 25 |
| | Depth , overall+ | 150 | 125 | 100 |
| Cored slabs in which the cores are circular or are higher than wide. Not less than 50 % of the gross across section of the floor should be solid material | Average cover to reinforcement | 65* | 40 | 25 |
| | Thickness under cores | 50 | 40 | 25 |
| | Depth , overall+ | 190 | 160 | 110 |
| Hollow box section with one or more longitudinal cavities which are wider than high | Average cover to reinforcement | 65* | 40 | 25 |
| | Thickness of bottom flange | 65 | 40 | 25 |
| | Depth , overall+ | 230 | 180 | 130 |
| Ribbed floor with hollow infill blocks of clay , or inverted T-section beams with hollow infill blocks of concrete or clay. A floor in which less than 50 % of the gross cross section is solid material must be provided with a 15 mm plaster coating on soffit | Average cover to reinforcement | 65* | 40 | 25 |
| | Width or rib , or beam , at soffit | 125 | 90 | 70 |
| | Depth , overall+ | 190 | 160 | 110 |
| Upright T-section | Average bottom cover to reinforcement | 100* | 65* | 40 |
| | Side cover to reinforcement | 100 | 65 | 40 |
| | Least width or downstanding leg | 250 | 150 | 90 |
| | Thickness of flange+ | 150 | 125 | 100 |
| Inverted channel sections with radius at intersection of soffits with top of leg not exceeding depth of section | Average bottom cover to reinforcement | 100* | 65* | 40 |
| | Side cover to reinforcement | 50 | 35 | 20 |
| | Least width or downstanding leg | 125 | 75 | 45 |
| | Thickness at crown+ | 150 | 125 | 100 |
| Inverted channel sections or U-sections with radius at intersection of soffits with top of leg exceeding dept of section | Average bottom cover to reinforcement | 100* | 65* | 40 |
| | Side cover to reinforcement | 50 | 35 | 20 |
| | Least width or downstanding leg | 110 | 70 | 45 |
| | Thickness at crown+ | 150 | 125 | 100 |

* Supplementary reinforcement, to hold the concrete cover in position, may be necessary.

+ Non-combustible screeds and finishes may be included in these dimensions.

APPENDIX D

PERMITTED LIMITS OF UNPROTECTED AREAS

PART 1

CALCULATION OF PERMITTED LIMITS OF UNPROTECTED AREAS

General rules applicable to this Appendix

1. The permitted limit of unprotected areas in any side of a station or compartment shall be calculated by reference to the requirements of Part II.
2. For the purposes of this Appendix, the expression "unprotected area" has the meaning ascribed to it by C1 2.1.2.75 but in calculating the size of unprotected areas or the permitted limit of unprotected areas, the following provisions shall apply -
 - (a) where any of an external wall is an unprotected area, only because it has combustible material attached to it as cladding, the area of that unprotected area shall be deemed to be half the area of such cladding;
 - (b) no account shall be taken of any of the following -
 - (i) an unprotected area which does not exceed 0.1 m^2 and which is not less than 1.5 m from any other unprotected area in the same side of the station or compartment (unless that other falls within (iii) below);
 - (ii) one or more unprotected areas having an area (or if more than one an aggregate area) not exceeding 1 m^2 and not less than 4 m from any other unprotected area in the same of the station or compartment (except any such area as is specified in (1) above);
 - (iii) an unprotected area in any part of an external wall which forms part of a protected shaft;
 - (iv) an unprotected area in the side of a station not divided into compartments, if the area is not less than 28 m above any ground adjoining that side of the station.

PART II

Rules of calculation by reference to an enclosing rectangle

3. The conditions of this Part of this Appendix shall be satisfied if a station or compartment is so situated that no point on the relevant boundary is either between the relevant plane of reference and the side of the station or compartment or at a distance from the relevant plane of reference which is less than the distance specified in the Tables to this Part of this Appendix, according to the purpose group of the station or compartment, the dimensions of the closing rectangle and the unprotected percentage.
4. For the purpose of this Part of this Appendix.

"relevant boundary" means as defined in Cl. 2.1.2.62 and for the purpose of this calculation is either paralleled to the side of the station under consideration or at an angle of not more than 80° with that side;

"plane of reference" means any vertical plane which touches the side or some part of the side of a station or compartment but which (however far extended) does not pass within the structure of such station or compartment (and for this purpose, any balcony, coping or similar projection shall be deemed not to be part either of that side or of the structure); and the relevant plane of reference shall in each case be taken as that most favourable in that respect to the person erecting the station;

"enclosing rectangle" means the smallest rectangle on the plane of reference which would-

- (a) enclose all the outer edge of any unprotected area of the station or, if the station is divided into compartments, of the compartment (other than any of an unprotected area which is at an angle of more than 80° to the plane of reference by line perpendicular to such plane);
- (b) have two horizontal sides: and
- (c) have height and width falling within those listed in the Tables to this Part of this Appendix:

"unprotected percentage" means the percentage of the area of the enclosing rectangle which is equal to the aggregate of the unprotected areas taken into account in calculating the enclosing rectangle and as projected on it.

APPENDIX D - continued

**TABLE 1 - COMPARTMENTS OF STATION
OFFICE AND PUBLIC AREA**

| Width of enclosing rectangle in metre | Distance in metres from relevant boundary for unprotected percentage not exceeding | | | | | | | | |
|---------------------------------------|--|-----|-----|------|-----|-----|-----|-----|------|
| | 20 | 30 | 40 | 50 | 60 | 70 | 80 | 90 | 100 |
| Enclosing rectangle 3m high | | | | | | | | | |
| 3 | 1.0 | 1.0 | 1.0 | 1.5 | 1.5 | 1.5 | 2.0 | 2.0 | 2.0 |
| 6 | 1.0 | 1.0 | 1.5 | 2.0 | 2.0 | 2.0 | 2.5 | 2.5 | 3.0 |
| 9 | 1.0 | 1.0 | 2.0 | 2.0 | 2.5 | 2.5 | 3.0 | 3.0 | 3.5 |
| 12 | 1.0 | 1.5 | 2.0 | 2.0 | 2.5 | 3.0 | 3.0 | 3.5 | 3.5 |
| 15 | 1.0 | 1.5 | 2.0 | 2.5 | 2.5 | 3.0 | 3.5 | 3.5 | 4.0 |
| 18 | 1.0 | 1.5 | 2.0 | 2.5 | 2.5 | 3.0 | 3.5 | 4.0 | 4.0 |
| 21 | 1.0 | 1.5 | 2.0 | 2.5 | 3.0 | 3.0 | 3.5 | 4.0 | 4.5 |
| 24 | 1.0 | 1.5 | 2.0 | 2.5 | 3.0 | 3.5 | 3.5 | 4.0 | 4.5 |
| 27 | 1.0 | 1.5 | 2.0 | 2.5 | 3.0 | 3.5 | 4.0 | 4.0 | 4.5 |
| 30 | 1.0 | 1.5 | 2.0 | 2.5 | 3.0 | 3.5 | 4.0 | 4.0 | 4.5 |
| 40 | 1.0 | 1.5 | 2.0 | 2.5 | 3.0 | 3.5 | 4.0 | 4.0 | 5.0 |
| No limit | 1.0 | 1.5 | 2.0 | 2.5 | 3.0 | 3.5 | 4.0 | 4.0 | 5.0 |
| Enclosing rectangle 6m high | | | | | | | | | |
| 3 | 1.0 | 1.0 | 1.5 | 2.0 | 2.0 | 2.0 | 2.5 | 2.5 | 3.0 |
| 6 | 1.0 | 1.5 | 2.0 | 2.5 | 3.0 | 3.0 | 3.5 | 4.0 | 4.0 |
| 9 | 1.0 | 2.0 | 2.5 | 3.0 | 3.5 | 4.0 | 4.5 | 4.5 | 5.0 |
| 12 | 1.5 | 2.5 | 3.0 | 3.5 | 4.0 | 4.5 | 5.0 | 5.0 | 5.5 |
| 15 | 1.5 | 2.5 | 3.0 | 4.0 | 4.5 | 5.0 | 5.5 | 5.5 | 6.0 |
| 18 | 1.5 | 2.5 | 3.5 | 4.0 | 4.5 | 5.0 | 5.5 | 6.0 | 6.5 |
| 21 | 1.5 | 2.5 | 3.5 | 4.0 | 5.0 | 5.5 | 6.0 | 6.5 | 7.0 |
| 24 | 1.5 | 2.5 | 3.5 | 4.5 | 5.0 | 5.5 | 6.0 | 7.0 | 7.0 |
| 27 | 1.5 | 2.5 | 3.5 | 4.5 | 5.0 | 6.0 | 6.5 | 7.0 | 7.5 |
| 30 | 1.5 | 2.5 | 3.5 | 4.5 | 5.0 | 6.0 | 6.5 | 7.0 | 8.0 |
| 40 | 1.5 | 2.5 | 3.5 | 4.5 | 5.5 | 6.5 | 7.0 | 8.0 | 8.5 |
| 50 | 1.5 | 2.5 | 3.5 | 4.5 | 5.5 | 6.5 | 7.5 | 8.0 | 9.0 |
| 60 | 1.5 | 2.5 | 3.5 | 5.0 | 5.5 | 6.5 | 7.5 | 8.5 | 9.5 |
| 80 | 1.5 | 2.5 | 3.5 | 5.0 | 6.0 | 7.0 | 7.5 | 8.5 | 9.5 |
| 100 | 1.5 | 2.5 | 3.5 | 5.0 | 6.0 | 7.0 | 8.0 | 8.5 | 10.0 |
| No limit | 1.5 | 2.5 | 3.5 | 25.0 | 6.0 | 7.0 | 8.0 | 8.5 | 10.0 |

APPENDIX D - continued

**TABLE 1 - COMPARTMENTS OF STATION
OFFICE AND PUBLIC AREA - continued**

| Width of enclosing rectangle in metre | Distance in metres from relevant boundary for unprotected percentage not exceeding | | | | | | | | |
|---------------------------------------|--|-----|-----|-----|------|------|------|------|------|
| | 20 | 30 | 40 | 50 | 60 | 70 | 80 | 90 | 100 |
| Enclosing rectangle 9m high | | | | | | | | | |
| 3 | 1.0 | 1.0 | 1.5 | 2.0 | 2.5 | 2.5 | 3.0 | 3.0 | 3.5 |
| 6 | 1.0 | 2.0 | 2.5 | 3.0 | 3.5 | 4.0 | 4.5 | 4.5 | 5.0 |
| 9 | 1.5 | 2.5 | 3.5 | 4.0 | 4.5 | 5.0 | 5.5 | 5.5 | 6.0 |
| 12 | 1.5 | 3.0 | 3.5 | 4.5 | 5.0 | 5.5 | 6.0 | 6.5 | 7.0 |
| 15 | 2.0 | 3.0 | 4.0 | 5.0 | 5.5 | 6.0 | 6.5 | 7.0 | 7.5 |
| 18 | 2.0 | 3.5 | 4.5 | 5.0 | 6.0 | 6.5 | 7.0 | 8.0 | 8.5 |
| 21 | 2.0 | 3.5 | 4.5 | 5.5 | 6.5 | 7.0 | 7.5 | 8.5 | 9.0 |
| 24 | 2.0 | 3.5 | 5.0 | 5.5 | 6.5 | 7.5 | 8.0 | 9.0 | 9.5 |
| 27 | 2.0 | 3.5 | 5.0 | 6.0 | 7.0 | 7.5 | 8.5 | 9.5 | 10.0 |
| 30 | 2.0 | 3.5 | 5.0 | 6.0 | 7.0 | 8.0 | 9.0 | 9.5 | 10.5 |
| 40 | 2.0 | 3.5 | 5.5 | 6.5 | 7.5 | 8.5 | 9.5 | 10.5 | 11.5 |
| 50 | 2.0 | 4.0 | 5.5 | 6.5 | 8.0 | 9.0 | 10.0 | 11.5 | 12.5 |
| 60 | 2.0 | 4.0 | 5.5 | 7.0 | 8.0 | 9.5 | 11.0 | 11.5 | 13.0 |
| 80 | 2.0 | 4.0 | 5.5 | 7.0 | 8.5 | 10.0 | 11.5 | 12.5 | 13.5 |
| 100 | 2.0 | 4.0 | 5.5 | 7.0 | 8.5 | 10.0 | 11.5 | 12.5 | 14.5 |
| 120 | 2.0 | 4.0 | 5.5 | 7.0 | 8.5 | 10.0 | 11.5 | 12.5 | 14.5 |
| No limit | 2.0 | 4.0 | 5.5 | 7.0 | 8.5 | 10.5 | 12.0 | 12.5 | 15.0 |
| Enclosing rectangle 12m high | | | | | | | | | |
| 3 | 1.0 | 1.5 | 2.0 | 2.0 | 2.5 | 3.0 | 3.0 | 3.5 | 3.5 |
| 6 | 1.5 | 2.5 | 3.0 | 3.5 | 4.0 | 4.5 | 5.0 | 5.0 | 5.5 |
| 9 | 1.5 | 3.0 | 3.5 | 4.5 | 5.0 | 5.5 | 6.0 | 6.5 | 7.0 |
| 12 | 1.5 | 3.5 | 4.5 | 5.0 | 6.0 | 6.5 | 7.0 | 7.5 | 8.0 |
| 15 | 2.5 | 3.5 | 5.0 | 5.5 | 6.5 | 7.0 | 8.0 | 8.5 | 9.0 |
| 18 | 2.5 | 4.0 | 5.0 | 6.0 | 7.0 | 7.5 | 8.5 | 9.0 | 10.0 |
| 21 | 2.5 | 4.0 | 5.5 | 6.5 | 7.5 | 8.5 | 9.0 | 10.0 | 10.5 |
| 24 | 2.5 | 4.5 | 6.0 | 7.0 | 8.0 | 8.5 | 9.5 | 10.5 | 11.5 |
| 27 | 2.5 | 4.5 | 6.0 | 7.0 | 8.0 | 9.0 | 10.5 | 11.0 | 12.0 |
| 30 | 2.5 | 4.5 | 6.5 | 7.5 | 8.5 | 9.5 | 10.5 | 11.5 | 12.5 |
| 40 | 2.5 | 5.0 | 6.5 | 8.0 | 9.5 | 10.5 | 12.0 | 12.0 | 14.0 |
| 50 | 2.5 | 5.0 | 7.0 | 8.5 | 10.0 | 11.0 | 13.0 | 14.0 | 15.0 |
| 60 | 2.5 | 5.0 | 7.0 | 9.0 | 10.5 | 12.0 | 13.5 | 14.5 | 16.0 |
| 80 | 2.5 | 5.0 | 7.0 | 9.0 | 11.0 | 13.0 | 14.5 | 16.0 | 17.0 |
| 100 | 2.5 | 5.0 | 7.5 | 9.5 | 11.5 | 13.5 | 15.0 | 16.5 | 18.0 |
| 120 | 2.5 | 5.0 | 7.5 | 9.5 | 11.5 | 13.5 | 15.0 | 17.0 | 18.5 |
| No limit | 2.5 | 5.0 | 7.5 | 9.5 | 12.0 | 14.0 | 15.5 | 17.0 | 19.0 |

APPENDIX D - continued

**TABLE 1 - COMPARTMENTS OF STATION
OFFICE AND PUBLIC AREA - continued**

| Width of enclosing rectangle in metre | Distance in metres from relevant boundary for unprotected percentage not exceeding | | | | | | | | |
|---------------------------------------|--|-----|------|------|------|------|------|------|------|
| | 20 | 30 | 40 | 50 | 60 | 70 | 80 | 90 | 100 |
| Enclosing rectangle 15m high | | | | | | | | | |
| 3 | 1.0 | 1.5 | 2.0 | 2.5 | 2.5 | 3.0 | 3.5 | 3.5 | 4.0 |
| 6 | 1.5 | 2.5 | 3.0 | 4.0 | 4.5 | 5.0 | 5.5 | 5.5 | 6.0 |
| 9 | 2.0 | 3.0 | 4.0 | 5.0 | 5.5 | 6.0 | 6.5 | 7.0 | 7.5 |
| 12 | 2.0 | 3.5 | 5.0 | 5.5 | 6.5 | 7.0 | 8.0 | 8.5 | 9.0 |
| 15 | 2.0 | 4.0 | 5.5 | 6.5 | 7.0 | 8.0 | 9.0 | 9.5 | 10.0 |
| 18 | 2.5 | 4.5 | 6.0 | 7.0 | 8.0 | 8.5 | 9.5 | 10.5 | 11.0 |
| 21 | 2.5 | 5.0 | 6.5 | 7.5 | 8.5 | 9.5 | 10.5 | 11.0 | 12.0 |
| 24 | 3.0 | 5.0 | 6.5 | 8.0 | 9.0 | 10.0 | 11.0 | 12.0 | 13.0 |
| 27 | 3.0 | 5.5 | 7.0 | 8.5 | 9.5 | 10.5 | 11.5 | 12.5 | 13.5 |
| 30 | 3.0 | 5.5 | 7.5 | 8.5 | 10.0 | 11.0 | 12.0 | 13.5 | 14.0 |
| 40 | 3.0 | 6.0 | 8.0 | 9.5 | 11.0 | 12.5 | 13.5 | 15.0 | 16.0 |
| 50 | 3.5 | 6.0 | 8.5 | 10.0 | 12.0 | 13.5 | 15.0 | 16.5 | 17.5 |
| 60 | 3.5 | 6.5 | 8.5 | 10.5 | 12.5 | 14.0 | 15.5 | 17.0 | 18.0 |
| 80 | 3.5 | 6.5 | 9.0 | 11.0 | 13.5 | 15.0 | 17.0 | 18.5 | 20.0 |
| 100 | 3.5 | 6.5 | 9.0 | 11.5 | 14.0 | 16.0 | 18.0 | 19.5 | 21.5 |
| 120 | 3.5 | 6.5 | 9.0 | 11.5 | 14.0 | 16.5 | 18.5 | 20.5 | 22.5 |
| No limit | 3.5 | 6.5 | 9.0 | 12.0 | 14.5 | 17.0 | 19.0 | 21.0 | 23.0 |
| Enclosing rectangle 18m high | | | | | | | | | |
| 3 | 1.0 | 1.5 | 2.0 | 2.5 | 2.5 | 3.0 | 3.5 | 4.0 | 4.0 |
| 6 | 1.5 | 2.5 | 3.5 | 4.0 | 4.5 | 5.0 | 5.5 | 6.0 | 6.5 |
| 9 | 2.0 | 3.5 | 4.5 | 5.0 | 6.0 | 6.5 | 7.0 | 8.0 | 8.5 |
| 12 | 2.5 | 4.0 | 5.0 | 6.0 | 7.0 | 7.5 | 8.5 | 9.0 | 10.0 |
| 15 | 2.5 | 4.5 | 6.0 | 7.0 | 8.0 | 8.5 | 9.5 | 10.5 | 11.0 |
| 18 | 2.5 | 5.0 | 6.5 | 7.5 | 8.5 | 9.5 | 11.0 | 11.5 | 13.0 |
| 21 | 3.0 | 5.5 | 7.0 | 8.0 | 9.5 | 10.5 | 11.5 | 12.5 | 13.0 |
| 24 | 3.0 | 5.5 | 7.5 | 8.5 | 10.0 | 11.0 | 12.0 | 13.0 | 14.0 |
| 27 | 3.5 | 6.0 | 8.0 | 9.0 | 10.5 | 11.5 | 12.5 | 13.5 | 14.5 |
| 30 | 3.5 | 6.5 | 8.0 | 9.5 | 11.0 | 12.0 | 13.5 | 14.5 | 15.5 |
| 40 | 4.0 | 7.0 | 9.0 | 11.0 | 12.0 | 13.5 | 15.0 | 16.5 | 17.5 |
| 50 | 4.0 | 7.0 | 9.5 | 11.5 | 13.0 | 15.0 | 16.5 | 18.0 | 19.0 |
| 60 | 4.0 | 7.5 | 10.0 | 12.0 | 14.0 | 16.0 | 17.5 | 19.5 | 20.5 |
| 80 | 4.0 | 7.5 | 10.0 | 13.0 | 15.0 | 17.0 | 19.0 | 21.0 | 22.5 |
| 100 | 4.0 | 7.5 | 10.0 | 13.5 | 16.0 | 18.0 | 20.5 | 22.5 | 24.0 |
| 120 | 4.0 | 7.5 | 10.0 | 14.0 | 16.5 | 19.0 | 21.0 | 23.5 | 25.5 |
| No limit | 4.0 | 8.0 | 10.0 | 14.0 | 17.0 | 19.5 | 22.0 | 24.0 | 26.5 |

APPENDIX D - continued

**TABLE 1 - COMPARTMENTS OF STATION
OFFICE AND PUBLIC AREA - continued**

| Width of enclosing rectangle in metre | Distance in metres from relevant boundary for unprotected percentage not exceeding | | | | | | | | |
|---------------------------------------|--|------|------|------|------|------|------|------|------|
| | 20 | 30 | 40 | 50 | 60 | 70 | 80 | 90 | 100 |
| Enclosing rectangle 21m high | | | | | | | | | |
| 3 | 0.5 | 1.5 | 2.0 | 2.5 | 3.0 | 3.0 | 3.5 | 4.0 | 4.5 |
| 6 | 1.5 | 2.5 | 3.5 | 4.0 | 5.0 | 5.5 | 6.0 | 6.5 | 7.0 |
| 9 | 2.0 | 3.5 | 4.5 | 5.5 | 6.5 | 7.0 | 7.5 | 8.5 | 9.0 |
| 12 | 2.5 | 4.0 | 5.5 | 6.5 | 7.5 | 8.5 | 9.0 | 10.0 | 10.5 |
| 15 | 2.5 | 5.0 | 6.5 | 7.5 | 8.5 | 9.5 | 10.5 | 11.0 | 12.0 |
| 18 | 3.0 | 5.5 | 7.0 | 8.0 | 9.5 | 10.5 | 11.5 | 12.5 | 13.0 |
| 21 | 3.0 | 6.0 | 7.5 | 9.0 | 10.5 | 11.0 | 12.5 | 13.5 | 14.0 |
| 24 | 3.5 | 6.0 | 8.0 | 9.5 | 10.5 | 12.0 | 13.0 | 14.0 | 15.0 |
| 27 | 3.5 | 6.5 | 8.5 | 10.0 | 11.5 | 13.0 | 14.0 | 15.0 | 16.0 |
| 30 | 4.0 | 7.0 | 9.0 | 10.5 | 12.0 | 13.0 | 14.5 | 16.0 | 16.5 |
| 40 | 4.5 | 7.5 | 10.0 | 12.0 | 13.5 | 15.0 | 16.5 | 18.0 | 19.0 |
| 50 | 4.5 | 8.0 | 11.0 | 13.0 | 14.5 | 16.5 | 18.0 | 20.0 | 21.0 |
| 60 | 4.5 | 8.5 | 11.5 | 13.5 | 15.5 | 17.5 | 19.5 | 21.0 | 22.5 |
| 80 | 4.5 | 8.5 | 12.0 | 14.5 | 17.0 | 19.0 | 21.0 | 23.5 | 25.0 |
| 100 | 4.5 | 9.0 | 12.0 | 15.5 | 18.0 | 20.5 | 22.5 | 25.0 | 27.0 |
| 120 | 4.5 | 9.0 | 12.0 | 16.0 | 18.5 | 21.5 | 23.5 | 26.5 | 28.5 |
| No limit | 4.5 | 9.0 | 12.0 | 16.0 | 19.0 | 22.0 | 25.0 | 26.5 | 29.5 |
| Enclosing rectangle 24m high | | | | | | | | | |
| 3 | 0.5 | 1.5 | 2.0 | 2.5 | 3.0 | 3.5 | 3.5 | 4.0 | 4.5 |
| 6 | 1.5 | 2.5 | 3.5 | 4.5 | 5.0 | 5.5 | 6.0 | 7.0 | 7.0 |
| 9 | 2.0 | 3.5 | 5.0 | 5.5 | 6.5 | 7.5 | 8.0 | 9.0 | 9.5 |
| 12 | 2.5 | 4.5 | 6.0 | 7.0 | 8.0 | 8.5 | 9.5 | 10.5 | 11.5 |
| 15 | 3.0 | 5.0 | 6.5 | 8.0 | 9.0 | 10.0 | 11.0 | 12.0 | 13.0 |
| 18 | 3.0 | 5.5 | 7.5 | 8.5 | 10.0 | 11.0 | 12.0 | 13.0 | 14.0 |
| 21 | 3.5 | 6.0 | 8.0 | 9.5 | 10.5 | 12.0 | 13.0 | 14.0 | 15.0 |
| 24 | 3.5 | 6.5 | 8.5 | 10.0 | 11.5 | 12.5 | 14.0 | 15.0 | 16.0 |
| 27 | 4.0 | 7.0 | 9.0 | 11.0 | 12.5 | 13.5 | 15.0 | 16.0 | 17.0 |
| 30 | 4.0 | 7.5 | 9.5 | 11.5 | 13.0 | 14.0 | 15.5 | 17.0 | 18.0 |
| 40 | 4.5 | 8.5 | 11.0 | 13.0 | 14.5 | 16.0 | 18.0 | 19.0 | 20.5 |
| 50 | 5.0 | 9.0 | 12.0 | 14.0 | 16.0 | 17.5 | 19.5 | 21.0 | 22.5 |
| 60 | 5.0 | 9.5 | 12.5 | 15.0 | 17.0 | 19.0 | 21.0 | 23.0 | 24.5 |
| 80 | 5.0 | 10.0 | 13.5 | 16.5 | 18.5 | 21.0 | 23.5 | 25.5 | 27.5 |
| 100 | 5.0 | 10.0 | 13.5 | 17.0 | 20.0 | 22.5 | 25.0 | 27.5 | 29.5 |
| 120 | 5.5 | 10.0 | 13.5 | 17.5 | 20.5 | 23.5 | 26.5 | 29.0 | 31.0 |
| No limit | 5.5 | 10.0 | 13.5 | 18.0 | 21.0 | 24.0 | 27.5 | 30.0 | 32.5 |

APPENDIX D - continued

**TABLE 1 - COMPARTMENTS OF STATION
OFFICE AND PUBLIC AREA - continued**

| Width of enclosing rectangle in metre | Distance in metres from relevant boundary for unprotected percentage not exceeding | | | | | | | | |
|---------------------------------------|--|------|------|------|------|------|------|------|------|
| | 20 | 30 | 40 | 50 | 60 | 70 | 80 | 90 | 100 |
| Enclosing rectangle 27m high | | | | | | | | | |
| 3 | 1.0 | 1.5 | 2.0 | 2.5 | 3.0 | 3.5 | 4.0 | 4.0 | 4.5 |
| 6 | 1.5 | 2.5 | 3.5 | 4.5 | 5.0 | 6.0 | 6.5 | 7.0 | 7.5 |
| 9 | 2.0 | 3.5 | 5.0 | 6.0 | 7.0 | 7.5 | 8.5 | 9.5 | 10.0 |
| 12 | 2.5 | 4.5 | 6.0 | 7.0 | 8.0 | 9.0 | 10.5 | 11.0 | 12.0 |
| 15 | 3.0 | 5.5 | 7.0 | 8.5 | 9.5 | 10.5 | 11.5 | 12.5 | 13.5 |
| 18 | 3.5 | 6.0 | 8.0 | 9.0 | 10.5 | 11.5 | 12.5 | 13.5 | 14.5 |
| 21 | 3.5 | 6.5 | 8.5 | 10.0 | 11.5 | 13.0 | 14.0 | 15.0 | 16.0 |
| 24 | 3.5 | 7.0 | 9.0 | 11.0 | 12.5 | 13.5 | 15.0 | 16.0 | 17.0 |
| 27 | 4.0 | 7.5 | 10.0 | 11.5 | 13.0 | 14.0 | 16.0 | 17.0 | 18.0 |
| 30 | 4.0 | 8.0 | 10.0 | 12.0 | 13.5 | 15.0 | 17.0 | 18.0 | 19.0 |
| 40 | 5.0 | 9.0 | 11.5 | 14.0 | 15.5 | 17.5 | 19.0 | 20.5 | 22.0 |
| 50 | 5.5 | 9.5 | 12.5 | 15.0 | 17.0 | 19.0 | 21.0 | 22.5 | 24.0 |
| 60 | 5.5 | 10.5 | 13.5 | 16.0 | 18.5 | 20.5 | 22.5 | 24.5 | 26.5 |
| 80 | 6.0 | 11.0 | 14.5 | 17.5 | 20.5 | 22.5 | 25.0 | 27.5 | 29.5 |
| 100 | 6.0 | 11.0 | 15.5 | 19.0 | 21.5 | 24.5 | 27.0 | 30.0 | 32.0 |
| 120 | 6.0 | 11.5 | 15.5 | 19.5 | 22.5 | 26.0 | 28.5 | 32.0 | 34.0 |
| No limit | 6.0 | 11.5 | 15.5 | 20.0 | 23.5 | 27.0 | 29.5 | 33.0 | 35.0 |

APPENDIX D - continued

**TABLE 2 - COMPARTMENTS OF STATION
COMMERCIAL AND ANCILLARY AREA**

| Width of enclosing rectangle in metre | Distance in metres from relevant boundary for unprotected percentage not exceeding | | | | | | | | |
|---------------------------------------|--|-----|-----|------|------|------|------|------|------|
| | 20 | 30 | 40 | 50 | 60 | 70 | 80 | 90 | 100 |
| Enclosing rectangle 3m high | | | | | | | | | |
| 3 | 1.0 | 1.5 | 2.0 | 2.0 | 2.5 | 2.5 | 2.5 | 3.0 | 3.0 |
| 6 | 1.5 | 2.0 | 2.5 | 3.0 | 3.0 | 3.5 | 3.5 | 4.0 | 4.0 |
| 9 | 1.5 | 2.5 | 3.0 | 3.5 | 4.0 | 4.0 | 4.5 | 5.0 | 5.0 |
| 12 | 2.0 | 2.5 | 3.0 | 3.5 | 4.0 | 4.5 | 5.0 | 5.5 | 5.5 |
| 15 | 2.0 | 2.5 | 3.5 | 4.0 | 4.5 | 5.0 | 5.5 | 6.0 | 6.0 |
| 18 | 2.0 | 2.5 | 3.5 | 4.0 | 5.0 | 5.0 | 6.0 | 6.5 | 6.5 |
| 21 | 2.0 | 3.0 | 3.5 | 4.5 | 5.0 | 5.5 | 6.0 | 6.5 | 7.0 |
| 24 | 2.0 | 3.0 | 3.5 | 4.5 | 5.0 | 5.5 | 6.0 | 7.0 | 7.5 |
| 27 | 2.0 | 3.0 | 4.0 | 4.5 | 5.5 | 6.0 | 6.5 | 7.0 | 7.5 |
| 30 | 2.0 | 3.0 | 4.0 | 4.5 | 5.5 | 6.0 | 6.5 | 7.5 | 8.0 |
| 40 | 2.0 | 3.0 | 4.0 | 5.0 | 5.5 | 6.5 | 7.0 | 8.0 | 8.5 |
| 50 | 2.0 | 3.0 | 4.0 | 5.0 | 6.0 | 6.5 | 7.5 | 8.0 | 9.0 |
| 60 | 2.0 | 3.0 | 4.0 | 5.0 | 6.0 | 7.0 | 7.5 | 8.5 | 9.5 |
| 80 | 2.0 | 3.0 | 4.0 | 5.0 | 6.0 | 7.0 | 8.0 | 9.0 | 9.5 |
| No limit | 2.0 | 3.0 | 4.0 | 5.0 | 6.0 | 7.0 | 8.0 | 9.0 | 10.0 |
| Enclosing rectangle 6m high | | | | | | | | | |
| 3 | 1.5 | 2.0 | 2.5 | 3.0 | 3.0 | 3.5 | 3.5 | 4.0 | 4.0 |
| 6 | 2.0 | 3.0 | 3.5 | 4.0 | 4.5 | 5.0 | 5.5 | 5.5 | 6.0 |
| 9 | 2.5 | 3.5 | 4.5 | 5.0 | 5.5 | 6.0 | 6.5 | 7.0 | 7.0 |
| 12 | 3.0 | 4.0 | 5.0 | 5.5 | 6.5 | 7.0 | 7.5 | 8.0 | 8.5 |
| 15 | 3.0 | 4.5 | 5.5 | 6.0 | 7.0 | 7.5 | 8.0 | 9.0 | 9.0 |
| 18 | 3.5 | 4.5 | 5.5 | 6.5 | 7.5 | 8.0 | 9.0 | 9.5 | 10.0 |
| 21 | 3.5 | 5.0 | 6.0 | 7.0 | 8.0 | 9.0 | 9.5 | 10.0 | 10.5 |
| 24 | 3.5 | 5.0 | 6.0 | 7.0 | 8.5 | 9.5 | 10.0 | 10.5 | 11.0 |
| 27 | 3.5 | 5.0 | 6.5 | 7.5 | 8.5 | 9.5 | 10.5 | 11.0 | 12.0 |
| 30 | 3.5 | 5.0 | 6.5 | 8.0 | 9.0 | 10.0 | 11.0 | 12.0 | 12.5 |
| 40 | 3.5 | 5.5 | 7.0 | 8.5 | 10.0 | 11.0 | 12.0 | 13.0 | 14.0 |
| 50 | 3.5 | 5.5 | 7.5 | 9.0 | 10.5 | 11.5 | 13.0 | 14.0 | 15.0 |
| 60 | 3.5 | 5.5 | 7.5 | 9.5 | 11.0 | 12.0 | 13.5 | 15.0 | 16.0 |
| 80 | 3.5 | 6.0 | 7.5 | 9.5 | 11.5 | 13.0 | 14.5 | 16.0 | 17.5 |
| 100 | 3.5 | 6.0 | 8.0 | 10.0 | 12.0 | 13.5 | 15.0 | 16.5 | 18.0 |
| 120 | 3.5 | 6.0 | 8.0 | 10.0 | 12.0 | 14.0 | 15.5 | 17.0 | 19.0 |
| No limit | 3.5 | 6.0 | 8.0 | 10.0 | 12.0 | 14.0 | 16.0 | 18.0 | 19.0 |

APPENDIX D - continued

**TABLE 2 - COMPARTMENTS OF STATION
COMMERCIAL AND ANCILLARY AREA - continued**

| Width of enclosing rectangle in metre | Distance in metres from relevant boundary for unprotected percentage not exceeding | | | | | | | | |
|---------------------------------------|--|------|------|------|------|------|------|------|------|
| | 20 | 30 | 40 | 50 | 60 | 70 | 80 | 90 | 100 |
| Enclosing rectangle 9m high | | | | | | | | | |
| 3 | 1.5 | 2.5 | 3.0 | 3.5 | 4.0 | 4.0 | 4.5 | 5.0 | 5.0 |
| 6 | 2.5 | 3.5 | 4.5 | 5.0 | 5.5 | 6.0 | 6.5 | 7.0 | 7.0 |
| 9 | 3.5 | 4.5 | 5.5 | 6.0 | 6.5 | 7.5 | 8.0 | 8.5 | 9.0 |
| 12 | 3.5 | 5.0 | 6.0 | 7.0 | 7.5 | 8.5 | 9.0 | 9.5 | 10.5 |
| 15 | 4.0 | 5.5 | 6.5 | 7.5 | 8.5 | 9.5 | 10.0 | 11.0 | 11.5 |
| 18 | 4.5 | 6.0 | 7.0 | 8.5 | 9.5 | 10.0 | 11.0 | 12.0 | 12.5 |
| 21 | 4.5 | 6.5 | 7.5 | 9.0 | 10.0 | 11.0 | 12.0 | 13.0 | 13.5 |
| 24 | 5.0 | 6.5 | 8.0 | 9.5 | 11.0 | 12.0 | 13.0 | 13.5 | 14.5 |
| 27 | 5.0 | 7.0 | 8.5 | 10.0 | 11.5 | 12.5 | 13.5 | 14.5 | 15.0 |
| 30 | 5.0 | 7.0 | 9.0 | 10.5 | 12.0 | 13.0 | 14.0 | 15.0 | 16.0 |
| 40 | 5.5 | 7.5 | 9.5 | 11.5 | 13.0 | 14.5 | 15.5 | 17.0 | 17.5 |
| 50 | 5.5 | 8.0 | 10.0 | 12.5 | 14.0 | 15.5 | 17.0 | 18.5 | 19.5 |
| 60 | 5.5 | 8.0 | 11.0 | 13.0 | 15.0 | 16.5 | 18.0 | 19.5 | 21.0 |
| 80 | 5.5 | 8.5 | 11.5 | 13.5 | 16.0 | 17.5 | 19.5 | 21.5 | 23.0 |
| 100 | 5.5 | 8.5 | 11.5 | 14.5 | 16.5 | 18.5 | 21.0 | 22.5 | 24.5 |
| 120 | 5.5 | 8.5 | 11.5 | 14.5 | 17.0 | 19.5 | 21.5 | 23.5 | 26.0 |
| No limit | 5.5 | 8.5 | 11.5 | 15.0 | 17.5 | 20.0 | 22.5 | 24.5 | 27.0 |
| Enclosing rectangle 12m high | | | | | | | | | |
| 3 | 2.0 | 2.5 | 3.0 | 3.5 | 4.0 | 4.5 | 5.0 | 5.5 | 5.5 |
| 6 | 3.0 | 4.0 | 5.0 | 5.5 | 6.5 | 7.0 | 7.5 | 8.0 | 8.5 |
| 9 | 3.5 | 5.0 | 6.0 | 7.0 | 7.5 | 8.5 | 9.0 | 9.5 | 10.5 |
| 12 | 4.5 | 6.0 | 7.0 | 8.0 | 9.0 | 9.5 | 11.0 | 11.5 | 12.0 |
| 15 | 5.0 | 6.5 | 8.0 | 9.0 | 10.0 | 11.0 | 12.0 | 13.0 | 13.5 |
| 18 | 5.0 | 7.0 | 8.5 | 10.0 | 11.0 | 12.0 | 13.0 | 14.0 | 14.5 |
| 21 | 5.5 | 7.5 | 9.0 | 10.5 | 12.0 | 13.0 | 14.0 | 15.0 | 16.0 |
| 24 | 6.0 | 8.0 | 9.5 | 11.5 | 12.5 | 14.0 | 15.0 | 16.0 | 16.5 |
| 27 | 6.0 | 8.0 | 10.5 | 12.0 | 13.5 | 14.5 | 16.0 | 17.0 | 17.5 |
| 30 | 6.5 | 8.5 | 10.5 | 12.5 | 14.0 | 15.0 | 16.5 | 17.5 | 18.5 |
| 40 | 6.5 | 9.5 | 12.0 | 14.0 | 15.5 | 17.5 | 18.5 | 20.0 | 21.0 |
| 50 | 7.0 | 10.0 | 13.0 | 15.0 | 17.0 | 19.0 | 20.5 | 23.0 | 23.0 |
| 60 | 7.0 | 10.5 | 13.5 | 16.0 | 18.0 | 20.0 | 21.5 | 23.5 | 25.0 |
| 80 | 7.0 | 11.0 | 14.5 | 17.0 | 19.5 | 21.5 | 23.5 | 26.0 | 27.5 |
| 100 | 7.5 | 11.5 | 15.0 | 18.0 | 21.0 | 23.0 | 25.5 | 28.0 | 30.0 |
| 120 | 7.5 | 11.5 | 15.0 | 18.5 | 22.0 | 24.0 | 27.0 | 29.5 | 31.5 |
| No limit | 7.5 | 12.0 | 15.5 | 19.0 | 22.5 | 25.0 | 28.0 | 30.5 | 34.0 |

APPENDIX D - continued

**TABLE 2 - COMPARTMENTS OF STATION
COMMERCIAL AND ANCILLARY AREA - continued**

| Width of enclosing rectangle in metre | Distance in metres from relevant boundary for unprotected percentage not exceeding | | | | | | | | |
|---------------------------------------|--|------|------|------|------|------|------|------|------|
| | 20 | 30 | 40 | 50 | 60 | 70 | 80 | 90 | 100 |
| Enclosing rectangle 15m high | | | | | | | | | |
| 3 | 2.0 | 2.5 | 3.5 | 4.0 | 4.5 | 5.0 | 535 | 6.0 | 6.0 |
| 6 | 3.0 | 4.5 | 5.5 | 6.0 | 7.0 | 7.5 | 8.0 | 9.0 | 9.0 |
| 9 | 4.0 | 5.5 | 6.5 | 7.5 | 8.5 | 9.5 | 10.0 | 11.0 | 11.5 |
| 12 | 5.0 | 6.5 | 8.0 | 9.0 | 10.0 | 11.0 | 12.0 | 13.0 | 13.5 |
| 15 | 5.5 | 7.0 | 9.0 | 10.0 | 11.5 | 12.5 | 13.5 | 14.5 | 15.0 |
| 18 | 6.0 | 8.0 | 9.5 | 11.0 | 12.5 | 13.5 | 14.5 | 15.5 | 16.5 |
| 21 | 6.5 | 8.5 | 10.5 | 12.0 | 13.5 | 14.5 | 16.0 | 16.5 | 17.5 |
| 24 | 6.5 | 9.0 | 11.0 | 13.0 | 14.5 | 15.5 | 17.0 | 18.0 | 19.0 |
| 27 | 7.0 | 9.5 | 11.5 | 13.5 | 15.0 | 16.5 | 18.0 | 19.0 | 20.0 |
| 30 | 7.5 | 10.0 | 12.0 | 14.0 | 16.0 | 17.0 | 18.5 | 20.0 | 21.0 |
| 40 | 8.0 | 11.0 | 13.5 | 16.0 | 18.0 | 19.5 | 21.0 | 22.5 | 23.5 |
| 50 | 8.5 | 12.0 | 15.0 | 17.5 | 19.5 | 21.9 | 23.0 | 25.0 | 26.0 |
| 60 | 8.5 | 12.5 | 15.5 | 18.0 | 21.0 | 23.5 | 25.0 | 27.0 | 28.0 |
| 80 | 9.0 | 13.5 | 17.0 | 20.0 | 23.0 | 25.5 | 28.0 | 30.0 | 31.5 |
| 100 | 9.0 | 14.0 | 18.0 | 21.5 | 24.5 | 27.5 | 30.0 | 32.5 | 34.5 |
| 120 | 9.0 | 14.0 | 18.5 | 22.5 | 25.5 | 28.5 | 31.5 | 34.5 | 37.0 |
| No limit | 9.0 | 14.5 | 19.0 | 23.0 | 27.0 | 30.0 | 34.0 | 36.0 | 39.0 |
| Enclosing rectangle 18m high | | | | | | | | | |
| 3 | 2.0 | 2.5 | 3.5 | 4.0 | 5.0 | 5.0 | 6.0 | 6.5 | 6.5 |
| 6 | 3.5 | 4.5 | 5.5 | 6.5 | 7.5 | 8.0 | 9.0 | 9.5 | 10.0 |
| 9 | 4.5 | 6.0 | 7.0 | 8.5 | 9.5 | 10.0 | 11.0 | 12.0 | 12.5 |
| 12 | 5.0 | 7.0 | 8.5 | 10.0 | 11.0 | 12.0 | 13.0 | 14.0 | 14.5 |
| 15 | 6.0 | 8.0 | 9.5 | 11.0 | 12.5 | 13.5 | 14.5 | 15.5 | 16.5 |
| 18 | 6.5 | 8.5 | 11.0 | 12.0 | 13.5 | 14.5 | 16.0 | 17.0 | 18.0 |
| 21 | 7.0 | 9.0 | 11.5 | 13.0 | 14.5 | 16.0 | 17.0 | 18.0 | 19.5 |
| 24 | 7.5 | 10.0 | 12.0 | 14.0 | 15.5 | 16.5 | 18.5 | 19.5 | 20.5 |
| 27 | 8.0 | 10.5 | 12.5 | 14.5 | 16.5 | 17.5 | 19.5 | 20.5 | 21.5 |
| 30 | 8.0 | 11.0 | 13.5 | 15.5 | 17.0 | 18.5 | 20.5 | 21.5 | 22.5 |
| 40 | 9.0 | 12.0 | 15.0 | 17.5 | 19.5 | 21.5 | 23.5 | 25.0 | 26.0 |
| 50 | 9.5 | 13.0 | 16.5 | 19.0 | 21.5 | 23.5 | 26.0 | 27.5 | 29.0 |
| 60 | 10.0 | 14.0 | 17.5 | 20.5 | 23.0 | 26.0 | 27.5 | 29.5 | 31.0 |
| 80 | 10.0 | 15.0 | 19.0 | 22.5 | 26.0 | 28.5 | 31.0 | 33.5 | 35.0 |
| 100 | 10.0 | 16.0 | 20.5 | 24.0 | 28.0 | 31.0 | 33.5 | 36.0 | 38.5 |
| 120 | 10.0 | 16.5 | 21.0 | 25.5 | 29.5 | 32.5 | 35.5 | 39.0 | 41.5 |
| No limit | 10.0 | 17.0 | 22.0 | 26.5 | 30.5 | 34.0 | 37.0 | 41.0 | 43.5 |

APPENDIX D - continued

**TABLE 2 - COMPARTMENTS OF STATION
COMMERCIAL AND ANCILLARY AREA - continued**

| Width of enclosing rectangle in metre | Distance in metres from relevant boundary for unprotected percentage not exceeding | | | | | | | | |
|---------------------------------------|--|------|------|------|------|------|------|------|------|
| | 20 | 30 | 40 | 50 | 60 | 70 | 80 | 90 | 100 |
| Enclosing rectangle 21m high | | | | | | | | | |
| 3 | 2.0 | 3.0 | 3.5 | 4.5 | 5.0 | 5.5 | 6.0 | 6.5 | 7.0 |
| 6 | 3.5 | 5.0 | 6.0 | 7.0 | 8.0 | 9.0 | 9.5 | 10.0 | 10.5 |
| 9 | 4.5 | 6.5 | 7.5 | 9.0 | 10.0 | 11.0 | 12.0 | 13.0 | 13.5 |
| 12 | 5.5 | 7.5 | 9.0 | 10.5 | 12.0 | 13.0 | 14.0 | 15.0 | 16.0 |
| 15 | 6.5 | 8.5 | 1.05 | 12.0 | 13.5 | 14.5 | 16.0 | 16.5 | 17.5 |
| 18 | 7.0 | 9.5 | 11.5 | 13.0 | 14.5 | 16.0 | 17.0 | 18.0 | 19.5 |
| 21 | 7.5 | 10.0 | 12.5 | 14.0 | 15.5 | 17.0 | 18.5 | 20.0 | 21.0 |
| 24 | 8.0 | 10.5 | 13.0 | 15.0 | 16.0 | 18.0 | 20.0 | 21.0 | 22.0 |
| 27 | 8.5 | 11.5 | 14.0 | 16.0 | 18.0 | 19.0 | 21.0 | 22.5 | 23.5 |
| 30 | 9.0 | 12.0 | 14.5 | 16.5 | 18.5 | 20.5 | 22.0 | 23.5 | 25.0 |
| 40 | 10.0 | 13.5 | 16.5 | 19.0 | 21.5 | 23.0 | 25.5 | 27.0 | 28.5 |
| 50 | 11.0 | 14.5 | 18.0 | 21.0 | 23.5 | 25.5 | 28.0 | 30.0 | 31.5 |
| 60 | 11.5 | 15.5 | 19.5 | 22.5 | 25.5 | 28.0 | 30.5 | 32.5 | 33.5 |
| 80 | 12.0 | 17.0 | 21.0 | 25.0 | 28.5 | 31.5 | 34.0 | 36.5 | 38.5 |
| 100 | 12.0 | 18.0 | 22.5 | 27.0 | 31.0 | 34.5 | 37.0 | 40.0 | 42.0 |
| 120 | 12.0 | 18.5 | 23.5 | 28.5 | 32.5 | 36.5 | 39.5 | 43.0 | 45.5 |
| No limit | 12.0 | 19.0 | 25.0 | 29.5 | 34.5 | 38.0 | 41.5 | 45.5 | 48.0 |
| Enclosing rectangle 24m high | | | | | | | | | |
| 3 | 2.0 | 3.0 | 3.5 | 4.5 | 5.0 | 5.5 | 6.0 | 7.0 | 7.5 |
| 6 | 3.5 | 5.0 | 6.0 | 7.0 | 8.5 | 9.5 | 10.0 | 10.5 | 11.0 |
| 9 | 5.0 | 6.5 | 8.0 | 9.5 | 11.0 | 12.0 | 13.0 | 13.5 | 14.5 |
| 12 | 6.0 | 8.0 | 9.5 | 11.5 | 12.5 | 14.0 | 15.0 | 16.0 | 16.5 |
| 15 | 6.5 | 9.0 | 11.0 | 13.0 | 14.5 | 15.5 | 17.0 | 18.0 | 19.0 |
| 18 | 7.5 | 10.0 | 12.0 | 14.0 | 15.5 | 16.5 | 18.5 | 19.5 | 20.5 |
| 21 | 8.0 | 10.5 | 13.0 | 15.0 | 16.5 | 18.0 | 20.0 | 21.0 | 22.0 |
| 24 | 8.5 | 11.5 | 14.0 | 16.0 | 18.0 | 19.5 | 21.0 | 22.5 | 24.0 |
| 27 | 9.0 | 12.5 | 15.0 | 17.0 | 19.0 | 20.5 | 21.5 | 24.0 | 25.5 |
| 30 | 9.5 | 13.0 | 15.5 | 18.0 | 20.0 | 21.5 | 23.5 | 25.0 | 26.5 |
| 40 | 11.0 | 14.5 | 18.0 | 20.5 | 23.0 | 25.0 | 27.5 | 29.0 | 30.5 |
| 50 | 12.0 | 16.0 | 19.5 | 22.5 | 25.5 | 27.5 | 30.0 | 32.0 | 33.5 |
| 60 | 12.5 | 17.0 | 21.0 | 24.5 | 27.5 | 30.0 | 32.5 | 35.0 | 36.5 |
| 80 | 13.5 | 18.5 | 23.5 | 27.5 | 31.0 | 34.5 | 37.0 | 39.5 | 41.5 |
| 100 | 13.5 | 20.0 | 25.0 | 29.5 | 33.5 | 37.0 | 40.0 | 43.0 | 45.5 |
| 120 | 13.5 | 20.5 | 26.5 | 31.0 | 36.0 | 39.5 | 43.0 | 46.5 | 49.0 |
| No limit | 13.5 | 21.0 | 27.5 | 32.5 | 37.5 | 42.0 | 45.5 | 49.5 | 52.0 |

APPENDIX D - continued

**TABLE 2 - COMPARTMENTS OF STATION
COMMERCIAL AND ANCILLARY AREA - continued**

| Width of enclosing rectangle in metre | Distance in metres from relevant boundary for unprotected percentage not exceeding | | | | | | | | |
|---------------------------------------|--|------|------|------|------|------|------|------|------|
| | 20 | 30 | 40 | 50 | 60 | 70 | 80 | 90 | 100 |
| Enclosing rectangle 27m high | | | | | | | | | |
| 3 | 2.0 | 3.0 | 4.0 | 4.5 | 5.5 | 6.0 | 6.5 | 7.0 | 7.5 |
| 6 | 3.5 | 5.0 | 6.5 | 7.5 | 8.5 | 9.5 | 10.5 | 11.0 | 12.0 |
| 9 | 5.0 | 7.0 | 8.5 | 10.0 | 11.5 | 12.5 | 13.5 | 14.5 | 15.0 |
| 12 | 6.0 | 8.0 | 10.5 | 12.0 | 13.5 | 14.5 | 16.0 | 17.0 | 17.5 |
| 15 | 7.0 | 9.5 | 11.5 | 13.5 | 15.0 | 16.5 | 18.0 | 19.0 | 20.0 |
| 18 | 8.0 | 10.5 | 12.5 | 14.5 | 16.5 | 17.5 | 19.5 | 20.5 | 21.5 |
| 21 | 8.5 | 11.5 | 14.0 | 16.0 | 18.0 | 19.0 | 21.0 | 22.5 | 23.5 |
| 24 | 9.0 | 12.5 | 15.0 | 17.0 | 19.0 | 20.5 | 22.5 | 24.0 | 25.5 |
| 27 | 10.0 | 13.0 | 16.0 | 18.0 | 20.0 | 22.0 | 24.0 | 25.5 | 27.0 |
| 30 | 10.0 | 13.5 | 17.0 | 19.0 | 21.0 | 23.0 | 25.0 | 26.5 | 28.0 |
| 40 | 11.5 | 15.5 | 19.0 | 22.0 | 24.5 | 26.5 | 29.0 | 30.5 | 32.5 |
| 50 | 12.5 | 17.0 | 21.0 | 24.0 | 27.0 | 29.5 | 32.0 | 34.5 | 36.0 |
| 60 | 13.5 | 18.5 | 22.5 | 26.5 | 29.5 | 32.0 | 35.0 | 37.0 | 39.0 |
| 80 | 14.5 | 20.5 | 25.0 | 29.5 | 33.0 | 36.5 | 39.5 | 42.0 | 44.0 |
| 100 | 15.5 | 21.5 | 27.0 | 32.0 | 36.5 | 40.5 | 43.0 | 46.5 | 48.5 |
| 120 | 15.5 | 22.5 | 28.5 | 34.0 | 39.5 | 43.0 | 46.5 | 50.5 | 53.0 |
| No limit | 15.5 | 23.5 | 29.5 | 35.0 | 40.5 | 44.5 | 48.5 | 52.0 | 55.5 |

APPENDIX E ACCESSWAY

| | | | | | | | | |
|-------------|---|----------------------|----------|----------|------------|-----------|----------|------------|
| E.1 | In general, the minimum width of the accessway shall be 6m wide and the minimum length shall be 15m long. <i>Diagram E.1</i> shows the relationship between the accessway and parked fire engine with its front and rear jacks extended. | Accessway sizes | | | | | | |
| E.2 | <p>Accessway shall be on</p> <p>a) Suspended slabs, or</p> <p>b) On metalled or paved ground, or</p> <p>c) Ground laid with strengthened perforated slabs or</p> <p>d) Approved materials</p> <p>to withstand the loading requirements of fire engine.</p> | Accessway loading | | | | | | |
| E.3 | The accessway required to serve building shall be constructed to sustain the load of a 30 tonnes fire engine. The wheel load shall be considered separately with the jack loads for both global and local effects. | | | | | | | |
| E.4 | <p>Axles load for accessway shall be as follows:</p> <table border="0" style="margin-left: 40px;"> <tr> <td style="padding-right: 20px;">Front Axles</td> <td style="padding-right: 20px;">7,500 kg</td> <td>2 wheels</td> </tr> <tr> <td>Rear Axles</td> <td>21,000 kg</td> <td>8 wheels</td> </tr> </table> | Front Axles | 7,500 kg | 2 wheels | Rear Axles | 21,000 kg | 8 wheels | Axles load |
| Front Axles | 7,500 kg | 2 wheels | | | | | | |
| Rear Axles | 21,000 kg | 8 wheels | | | | | | |
| E.5 | The jack load shall be assumed to be uniformly distributed over a rectangular contact area of 923cm ² for both local and global analysis. | | | | | | | |
| E.6 | The maximum pressure on one jack, even in the worst case, will not exceed 80N/cm ² . | | | | | | | |
| E.7 | In the absence of more exact calculations, live load surcharge for accessway on suitable material properly consolidated may be assumed to be at least 10 kN/m ² . | | | | | | | |

APPENDIX E - continue

Diagram E.1

ACCESSWAY (WHEELS & JACKS LAYOUT)

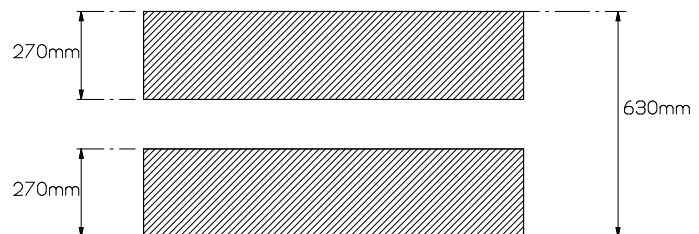
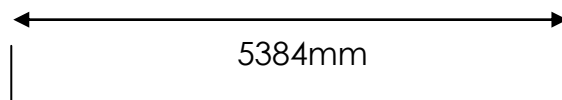
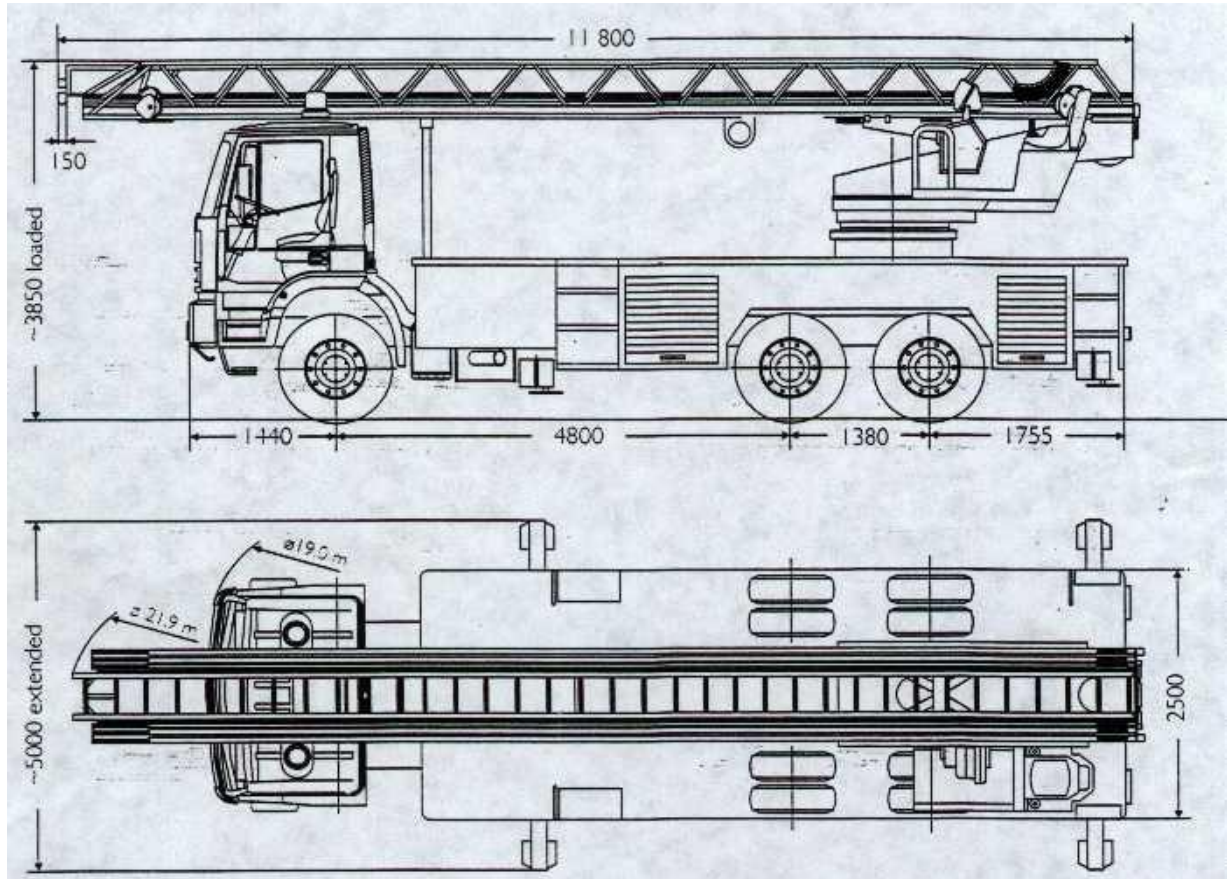

Wheel Spacing

**APPENDIX F
STANDBY FIRE HOSE FOR RISING MAIN**

| | | |
|-------|---|-------------------|
| F.1 | Type and folding method | |
| F.1.1 | The standby fire hose shall be of 63.5mm nominal internal diameter in order to ensure that the hose coupling will fit existing coupling tail pieces. The hose shall be rugged and capable of carrying water under substantive pressure in accordance with BS 6391. The fire hose shall be of type 3 as stipulated in BS 6391. | Type |
| F.1.2 | The fire hose couplings shall be manufactured to BS specification or equivalent and of light alloy or gunmetal. The coupling shall be of type 63.5mm and be of the instantaneous type with standard (double-pull) release mechanism. The couplings shall be tied in by binding with galvanised mild steel wire and applied over a hose guard of synthetic fibre. It shall be able to withstand a minimum working pressure of 15 bars. | Hose couplings |
| F.1.3 | Each hose shall have a standard length of 30m and shall be kept stowed in a Dutch Rolled position and housed in a glass-fronted cabinet. | Storage |
| F.2 | Position | |
| F.2.1 | The fire hose shall be installed just next to, but not more than 2m from the landing valve. | |
| F.2.2 | The entire fire hose and cabinet shall be out of direct sunlight. | |
| F.3 | Mounting | |
| | The wall mounted fire hose cabinet requirement shall be as follows: | Fire hose cabinet |
| | (i) The cabinet shall be firmly mounted on the wall and rigid to take either one or two fire hose weight. | |
| | (ii) The cabinet shall be constructed of non-combustible material. | |
| | (iii) The cabinet lock, if provided, shall be of the type that could be operated manually from the inside without the use of a key when the front plain glass/plastic (minimum 300mm x 300mm) is broken by the fire fighter. | |

- (iv) The cabinet swing door shall be made openable such that it will not obstruct the retrieving of the fire hose by the fire fighter.
- (v) The depth of the cabinet shall not exceed 250mm for one fire hose or 350mm for two fire hoses.
- (vi) The cabinet shall be painted in a contrasting colour such that it is conspicuous and easily identified.
- (vii) The words, "FIRE HOSE", with letter height of at least 50mm and shown in contrasting colour, shall be painted directly on the front panel.
- (viii) In lieu of the cabinet, a simple wall mounted cradle for the fire hose can be provided, but only in the riser main shaft. The cradle shall be constructed and positioned to facilitate the retrieving of fire hose by the fire fighter.
- (ix) The cradle (in lieu of the cabinet) shall be maintenance free. The fire hose installation height shall be 400mm to 1500mm above finished floor level.

F.4 General

- (i) Only clean, dry and compact rolled hose shall be placed in the cabinet.
- (ii) Two lengths of spare fire hoses shall be kept in stock and ready for replacement.
- (iii) BS 6391 stipulates the technical requirements for quality acceptance standards of the fire hose. In addition, the above requirements shall be applicable for acceptance of the standby fire hose.

Spare hoses

APPENDIX G TENABLE ENVIRONMENT

G.1 General

The purpose of this appendix is to provide guidelines for the details of the tenable environment.

G.2 Environmental Consideration

Some factors that should be considered in maintaining a tenable environment for periods of short duration are defined as follows:

(a) Heat effects

Exposure to heat can lead to life threat three basic ways:

- (1) Hyperthermia
- (2) Body surface burns
- (3) Respiratory tract burns

For use in the modeling of life threat due to heat exposure in fires, it is necessary to consider only two criteria - the threshold of burning of the skin and the exposure at which hyperthermia is sufficient to cause mental deterioration and thereby threaten survival.

Note that thermal burns to the respiratory tract from inhalation of air containing less than 10 percent by volume of water vapor do not occur in the absence of burns to the skin or the face; thus, tenability limits with regard to skin burns normally are lower than for burns to the respiratory tract. However, thermal burns to the respiratory tract can occur upon inhalation of air above 60°C that is saturated with water vapor.

The tenability limit for exposure of skin to radiant heat is approximately 2.5 kW/m². Below this incident heat flux level, exposure can be tolerated for 30 minutes or longer without significantly affecting the time available for escape. Above this threshold value, the time to burning of skin due to radiant heat decreases rapidly according to equation (1).

$$t_{rad} = 4q^{-1.35} \quad (1)$$

where:

t = time in minutes

q = radiant heat flux in kW/m²

Heat effects

As with toxic gases, an exposed occupant can be considered to accumulate a dose of radiant heat over a period of time. The fraction equivalent dose (FED) of radiant heat accumulated per minute is the reciprocal of t_{Irad} .

Radiant heat tends to be directional, producing localized heating of particular areas of skin even though the air temperature in contact with other parts of the body might be relatively low. Skin temperature depends on the balance between the rate of heat applied to the skin surface and the removal of heat subcutaneously by the blood. Thus, there is a threshold radiant flux below which significant heating of the skin is prevented but above which rapid heating occurs.

Based on the preceding information, it is estimated that the uncertainty associated with the use of equation (1) is ± 25 percent. Moreover, an irradiance of 2.5 kW/m^2 would correspond to a source surface temperature of approximately 200°C , which is most likely to be exceeded near the fire, where conditions are changing rapidly.

Calculation of the time to incapacitation under conditions of exposure to convected heat from air containing less than 10 percent by volume of water vapor can be made using either equation (2) or equation (3).

As with toxic gases, an exposed occupant can be considered to accumulate a dose of convected heat over a period of time. The FED of convected heat accumulated per minute is the reciprocal of t_{Iconv} .

Convected heat accumulated per minute depends on the extent to which an exposed occupant is clothed and the nature of the clothing. For fully clothed subjects, equation (2) is suggested:

$$t_{Iconv} = (4.1 \times 10^8)T^{-3.61} \quad (2)$$

where:

t_{Iconv} = time in minutes

T = temperature in $^\circ\text{C}$

For unclothed or lightly clothed subjects, it might be more appropriate to use equation (3):

$$t_{Iconv} = (5 \times 10^7)T^{-3.4} \quad (3)$$

where:

t_{Iconv} = time in minutes

T = temperature in °C

Equations (2) and (3) are empirical fits to human data. It is estimated that the uncertainty is ± 25 percent.

Thermal tolerance data for unprotected human skin suggest a limit of about 120°C for convected heat, above which there is, within minutes, onset of considerable pain along with the production of burns. Depending on the length of exposure, convective heat below this temperature can also cause hyperthermia.

The body of an exposed occupant can be regarded as acquiring a “dose” of heat over a period of time. A short exposure to a high radiant heat flux or temperature generally is less tolerable than a longer exposure to a lower temperature or heat flux. A methodology based on additive FEDs similar to that used with toxic gases can be applied. Providing that the temperature in the fire is stable or increasing, the total fractional effective dose of heat acquired during an exposure can be calculated using equation (4):

$$FED = \sum_{t_1}^{t_2} (1/t_{Irad} + 1/t_{Iconv}) \Delta t \quad (4)$$

Note 1: In areas within an occupancy where the radiant flux to the skin is under 2.5 kW/m², the first term in equation (4) is to be set at zero.

Note 2: The uncertainty associated with the use of this last equation would be dependent on the uncertainties with the use of the three earlier equations.

The time at which the FED accumulated sum exceeds an incapacitating threshold value of 0.3 represents the time available for escape for the chosen radiant and convective heat exposures.

(b) Air carbon monoxide content

Maximum of 2000ppm (parts per million) for a few seconds, averaging 1500ppm or less for the first 6 minutes of the exposure, averaging 800 ppm or less for the first 15 minutes of the exposure, averaging 50ppm or less for the remainder of the exposure;

Air carbon monoxide content

(c) Smoke obscuration levels

Smoke obscuration levels should be continuously maintained below the point at which a sign internally illuminated at 80 lux is discernible at 30m and doors and walls are discernible at 10 m. This is equivalent to a light attenuation coefficient of 0.267 per m.

Smoke obscuration levels

(d) Air velocities

Air velocities in the enclosed trainway should be greater than or equal to 0.76m/s and less than or equal to 11.18m/s;

Air velocities

(e) Noise levels

Maximum of 115dBA for a few seconds, maximum of 92dBA for the remainder of the exposure.

Noise levels

G.3 Geometric Consideration

Some factors that should be considered in establishing a tenable environment in stations are as follows:

- (a) The evacuation path requires a height clear of smoke of at least 2m. The current precision of modeling methods is within 25 percent. Therefore, in modeling methods a height of at least 2.5m should be maintained above any point along the surface of the evacuation pathway.
- (b) The application of tenability criteria at the perimeter of a fire is impractical. The zone of tenability should be defined to apply outside a boundary away from the perimeter of the fire. This distance will be dependent on the fire heat release rate and could be as much as 30m

APPENDIX H
NOTES ON THE USE OF INTUMESCENT PAINTS FOR PROTECTION TO
STRUCTURAL STEEL MEMBERS OF STATIONS

| | | |
|-------|--|-----------------|
| H.1 | Scope | Scope |
| H.1.1 | Intumescent paint is allowed to be used to protect the structural steel members of stations to achieve the required fire resistance. | |
| H.1.2 | For stations of habitable height not more than 24m, intumescent paint is allowed to be used to protect the structural steel columns and beams. | |
| H.1.3 | For stations of habitable height more than 24m, intumescent paint is allowed to be used to protect only the structural steel beams, excluding load transfer beams. | |
| H.2 | Standards | Standards |
| H.2.1 | The intumescent paint shall be subjected to the fire resistance test as detailed in BS 476 Pt 20/21 or its equivalent. | |
| H.2.2 | The intumescent paint shall also be subjected to weathering tests as detailed in BS 8202: Pt 2. Fire test for fire resistance performance shall be conducted on the specimens after the weather tests. The fire resistance rating of the tested specimen shall not be less than 75% of the original prototype. | |
| H.2.3 | The intumescent paint shall be listed under the Product Listing Scheme, administered by respective building material certification bodies. | |
| H.3 | Plan Submission | Plan submission |
| H.3.1 | The project QP shall submit a separate set of plans indicating the locations of the structural steel members that are/will be coated with intumescent paint. | |
| H.3.2 | If the station exceeds 24m in habitable height, a fire safety report shall be submitted together with the plan. | |
| H.4 | Signage | Signage |
| H.4.1 | A signage depicting the following minimum information shall be fixed at a conspicuous location: | |
| | a) Name of supplier | |

- b) Fire resistance rating of the intumescent paint
- c) Date of painting
- d) Expected date of re-painting.
- e) Caution note: “Caution: No other paint/coating shall be applied to the surfaces of the structural steel members protected by the intumescent paint system”

H.5 Inspection and Maintenance

Inspection and Maintenance

H.5.1 The Fire Safety Manager (FSM), if any, shall carry out regular inspection checks to ensure that the intumescent paint coatings are not damaged or tempered with. Records of inspection shall be properly kept.

H.5.2 Annual renewal of the Fire Certificate, where applicable, shall also include the inspection of the columns and beams coated with intumescent paint. The inspection shall be carried out by a Qualified Person (QP).

H.5.3 For addition/alteration works in a building where structural steel members are protected by intumescent paint, the following requirements must be complied with:

- a) The owner or tenant, assisted by the FSM, shall engage a QP who shall submit building plans to LTA (BCU). The building plans shall be accompanied by the QP’s declaration as to whether the existing columns beams coated with intumescent paint are/will be affected.
- b) Certificate of Registered Inspector Inspection shall be required.
- c) The fire safety report shall be updated accordingly.

H.5.4 There shall be no highly flammable/combustible materials stored within the vicinity of any structural steel members protected by intumescent paint.

APPENDIX J
FIRE SAFETY REQUIREMENTS FOR
RAPID TRANSIT STATIONS FOR PERSONS WITH DISABILITIES

J.1 SCOPE

- J.1.1 The scope of these requirements on the design and management of RTS stations covers the public area of RTS Stations and excludes RTS depots, ancillary buildings, viaducts and tunnels.
- J.1.2 These requirements are intended for the safe evacuation of Persons With Disabilities (PWDs) during fire emergency.

J.2 PRINCIPLES OF EVACUATION

- J.2.1 RTS station public areas are designed with barrier-free accessibility under the Building Control Act. The ingress/egress routes for PWDs shall also be used as evacuation routes for PWDs.
- J.2.2 RTS stations are of non-combustible construction. The station public areas are segregated from the ancillary areas by fire-rated construction, and are designed with emergency ventilation system to provide a tenable environment for evacuation in the event of fire emergency.
- J.2.3 Passenger lifts in stations are primarily provided for use by PWDs. These lifts that are located in the public area shall be used for the evacuation of PWDs.
- J.2.4 Management procedures and responsibilities shall be formulated for the evacuation of PWDs in the event of fire.

J.3 EVACUATION ROUTES

- J.3.1 The evacuation route for PWDs in the public areas shall comply with the general requirements of the BCA's Code on Accessibility in the Built Environment.

J.4 PASSENGER LIFTS

- J.4.1 All passenger lifts in RTS stations shall be used to evacuate PWDs in the event of fire emergency.
- J.4.2 Passenger lift shall have a clear platform size of minimum 1200mm width X 1400mm depth.

- J.4.3 Where passenger lifts in RTS stations are located within the public area and within one fire compartment, the lift shafts are not required to be fire-rated. It is also not required to provide fire-rated lift lobby at lift landings.
- J.4.4 From the platform level, PWDs shall use the passenger lift to reach the concourse level. Where concourse level is not the ground level, the PWDs shall be transferred to another lift that is connected to the ground level upon arrival at that concourse level. Directional signage shall be provided on the concourse level to direct PWDs to the lift(s) in accordance with the BCA's Code on Accessibility in the Built Environment.
- J.4.5 In the event of fire emergency, passenger lifts are not required to home to the designated floor. Passenger lifts are to be operated as in under normal conditions for use by PWDs to evacuate the station. Car call control within the lift car shall operate as per normal.
- J.4.6 Appropriate signage on the use of lift during emergency i.e. "In the Event of Emergency, Lift for Use by Persons with Disabilities Only" shall be displayed at the lift landing.
- J.4.7 Lifts in RTS stations shall be provided with electrical power supply from the RTS dual-feeder electrical power supply system for uninterrupted operation during fire emergency.
- J.4.8 Except on the designated floor as defined in SS 550, emergency fire phone shall be provided at each lift landing for PWDs to communicate with the Passenger Service Centre (PSC).

J.5 MANAGEMENT OF EVACUATION FOR PWDs

- J.5.1 Management procedures to assist the evacuation of PWDs during fire emergency shall be pre-planned by the Transit Operator. Proper procedures and effective practices will ensure the safety of PWDs in the event of fire emergency.
- J.5.2 Transit Operator shall ensure that the staff designated to help PWDs in the event of fire emergency are fully trained to execute the following evacuation procedure.

J.5.3 In the event of fire emergency:

- (a) Trained staff on duty shall check and provide necessary assistance to evacuate PWDs.
- (b) SCDF takes control of the situation upon their arrival at the scene. Trained staff shall assist SCDF (if required) to evacuate PWDs.
- (c) Procedures shall be tested at least once a year and involve both horizontal, if provided, and vertical evacuation.

